



BY

Firestone



**Application
Guide & Catalog**

Ride-Rite™ Air Springs

The added support your suspension needs for hauling.

Don't let massive bumps, potholes and sharp turns give you road-wince. Get the additional, individually adjustable support you need to balance your vehicle both front-to-back and side-to-side. So you can haul with comfort, confidence and control.

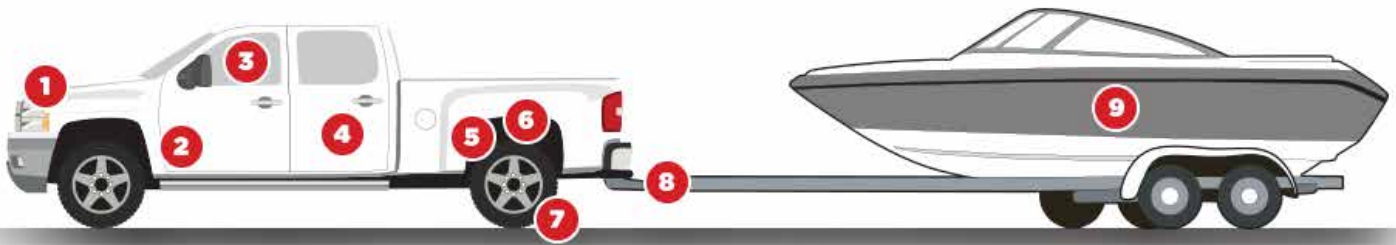

Benefits of Air Springs

- 1 Keeps the vehicle level so headlights don't aim too high
- 2 Increases steering control and braking effectiveness
- 3 Enhances your ride comfort with a heavy load in tow
- 4 Improves appearance (won't sag to either side – or either end)
- 5 Installs easily between the frame and axle
- 6 Adds life to suspension through additional support and reduced bottoming out
- 7 Reduces tire wear by balancing out your vehicle regardless of load placement
- 8 Prevents heavy loads from making your vehicle dangerously unbalanced
- 9 Protects cargo with less bottoming out

Load Assist Spring Features	Ride-Rite™	Work-Rite™	Coil-Rite™	Level-Rite™
Most Kits Are No Drill 	Yes	Yes	Yes	Yes
Avg. Install Time	1-2 hrs.	30-40 min.	1 hr.	1 hr.
Special Tools	No	No	No	No
Cost Indicator	\$\$	\$	\$	\$\$\$
Optional Accessories	See pgs. 53–55	See pgs. 53–55	See pgs. 53–55	See pgs. 53–55
Min-Max psi	5-100	n/a	5-30	10-100
Increases vehicle stability & reduces sway	Yes	Yes	Yes	Yes
Absorbs road shock	Yes	Yes	Yes	Yes
Reduces suspension fatigue	Yes	Yes	Yes	Yes
Improves loaded ride	Yes	Yes	Yes	Yes
Keeps vehicle level	Yes			
Air adjustable to level off-center loads	Yes			

Firestone's most popular and comprehensive air spring line, Ride-Rite kits can be installed on most light trucks, motor-homes, RVs, SUVs and vans. Each application is specifically designed to maximize the vehicle's safe load-carrying capacity, stability, ride quality and brake effectiveness.

- Provides load support through the use of air pressure that can be adjusted for changing loads
- Enhances the ride by reducing inter-leaf friction
- Individual inflation valves that allow for separate side-to-side or front-to-rear adjustment
- Most Ride-Rite kits are no-drill systems that utilizes vehicle's factory holes and mount between its frame and suspension
- Easy installation that typically takes 1 to 2 hours
- Kits come with a two-year limited warranty
- Supports up to 5,000 lbs per set (not to exceed vehicle's GVWR) and should be maintained between 10-100 psi



Air springs, brackets, hardware, air line, and separate valves for manual inflation are all included for a straightforward installation.



Ride-Rite kits improve the handling on light trucks, motorhomes, RVs, SUVs and vans.

Ride-Rite LS is Firestone's line of load adaptive shocks and is an ideal upgrade to Ride-Rite air springs.

- Ride-Rite LS is a tri-tube mono-flow shock absorber
- Deliver superior performance under a full range of load and temperature conditions
- Damping level is automatically controlled by the air pressure inside the spring
- Easy-to-install product comes complete with air line and "T" fittings



Ride-Rite LS

Like Ride-Rite air springs, the Sport-Rite air springs improve the ride and handling.

- Innovative tapered sleeve air springs, which are more conducive for specific applications
- Support up to 3,000 lbs. per set (not to exceed vehicle's GVWR) and should be maintained between 10-100 psi





Work-Rite™ Load Assist Springs

The progressive load-deflection characteristics of the Work-Rite kit will smooth your ride when your vehicle is fully loaded, and won't compromise your ride when it's not.

- Injection-molded and made of microcellular urethane
- Adjustable for individual loading scenarios using spacers provided in each kit
- Eight separate spring-geometry and stiffness combinations
- Most kits are a no-drill design using existing holes in the frame
- Requires only simple hand tools
- Maintenance-free
- Limited lifetime spring warranty



Work-Rite kits contain load assist springs, brackets, and hardware for a quick installation. Spacers may also be used.



Work-Rite products provide a maintenance-free option.



Coil-Rite™ Air Springs

If you're looking for a smoother ride for your vehicle that has a coil spring suspension, Firestone Coil-Rite air springs are what you need. Designed to fit inside existing coil springs to create a variable spring rate, Coil-Rite will level your vehicle and assist with more effective braking and handling, even under heavy loading and adverse road conditions.

- Control the air pressure in the air helper springs for varying loads and road conditions
- Spring performance can be altered as easily as inflating a tire
- Made of durable, elastic polyurethane
- Support 500-1000 lbs. per set (not to exceed vehicle's GVWR)
- Designed to work in temperatures between -40°F (-40°C) and 180°F (82°C)



Air helper springs, hardware, air line and separate valves for manual inflation are included in each Coil-Rite kit.



Designed for cars, minivans, vans, light trucks, RVs and SUVs that have coil springs.

Certain factory suspension configurations do not allow the fitment of a stand-alone air spring. In these instances, it is necessary to pair the air spring with the shock absorber to achieve meaningful load capability while maintaining a hassle-free installation. For these applications, Firestone has designed a fully-protected, reversible sleeve air spring and paired it with a high-performance Bilstein monotube shock absorber for perfectly matched performance characteristics over the entire operation range.

- Provides the perfect leveling solution for the front end of late model Dodge, Chevrolet and GMC trucks and SUVs used for snow-plowing, hauling slide-in-campers or that have large, heavy grill guards or bumpers.



Level-Rite products combine reversible sleeve air springs with high-performance shock absorbers.

Ram Air Conversion System



If you own a Ram 1500 (2009-2014) with rear coil spring suspension, you may have noticed that when your truck is fully loaded, the bed of your vehicle sags considerably more than it would with a leaf spring suspension. Firestone's solution to this problem is the Dodge Ram 1500 coil to air spring conversion. It is designed to replace the factory coil spring with an air spring, converting the rear suspension to an Airide™ suspension. The full air conversion provides a higher leveling capacity – up to the Gross Vehicle Weight Rating (GVWR) of the vehicle – than traditional systems, while smoothing the vehicle's ride.

- Keeps the vehicle level under all load conditions
- Maintains all the factory hardware and suspension geometry
- Easily installed with simple hand tools
- Improves steering and vehicle control
- Reduces bottoming out when adding a load
- Effortless loading and trailer attachment
- 6-inch kneel at the hitch by “exhausting” air from the springs
- No calibration is required
- Limited lifetime warranty on springs



Our Dodge Ram Air Conversion System keeps the vehicle level under all load conditions.

The 2009-2014 Dodge Ram 1500 Air Conversion System (2518) contains Airide™ springs, a Heavy Duty air compressor and 3 gallon tank, height sensors, kneel switch and hardware.

Air Leveling Front

This section is used to locate the air helper solution for the front of the vehicle.

Air Spring

If only a replacement air spring is required, use this part number.

Suggested Air Accessory

This is a guide to the air accessory system that may be selected to be used with the air helper spring: Light Duty, Standard Duty, Heavy Duty, Xtra, or Xtreme. To select your preferred air accessory system, see pages 53-55.



No Drill

Many Firestone kits are No Drill (indicated with a Y for Yes), which means these kits use the existing holes in the frame for installation and require only simple hand tools.

Front Kit

The 4-digit part number listed in this column is a complete air helper spring kit for the front of the vehicle.

Install Clock

This indicates an estimated average installation time in hours.

Product Codes

Product codes have been used by customers in a 4-digit and a 10-digit format. Below you will see how the 4-digit abbreviated code can be easily expanded into the 10-digit product code and vice versa.

	Prefix for Product Line	Example	
		4-Digit	10-Digit
Ride-Rite/Sport-Rite/Level-Rite	W21760-	2550	W217602550
Work-Rite	W27760-	8629	W277608629
Coil-Rite	W23760-	4100	W237604100
Air Command/Level Command	WR1760-	2540	WR17602540



Model	Year	Air Leveling Rear				
		Rear Kit	Type			Air Spring
Acura SUVs						
MDX	05-10	4179	C-R		2	6020
Audi Cars						
A3	10-14	4176	C-R	Y	1	6027
Buick Cars / Vans						
Century (fwd only)	82-96	4103	C-R	Y	1	6014
Century (rwd only)	73-87	4114	C-R	Y	1	6008
Electra (not sw)	85-96	4107	C-R	Y	1	6021
Grand Sport	73-87	4114	C-R	Y	1	6008
LeSabre (not sw) (fwd only)	00-04	4105	C-R	Y	1	6013
LeSabre FWD	86-99	4107	C-R	Y	1	6021
Lexus (rwd only)	73-87	4114	C-R	Y	1	6008
Park Avenue	97-05	4105	C-R	Y	1	6013
Park Avenue (not sw)	85-96	4107	C-R	Y	1	6021
Regal (rwd only)	73-87	4114	C-R	Y	1	6008
Riviera	95-98	4105	C-R	Y	1	6013
Riviera	79-85	4106	C-R	Y	1	6015
Skyhawk	82-89	4104	C-R	Y	1	6012
Skylark	85-96	4104	C-R	Y	1	6012
Somerset	85-87	4104	C-R	Y	1	6012
Terraza	05-07	4155	C-R	Y	1	6020
Cadillac Cars / SUVs						
Coupe Deville, Fleetwood, Sedan Deville, Touring Sedan (fwd only)	85-93	4107	C-R	Y	1	6021
CTS	05-11	4168	C-R	Y	1	6027
El Dorado	79-85	4106	C-R	Y	1	6015
Escalade (2WD, 4WD) (4 door only)	99-00	2101	R-R	Y	2	6781
Escalade, ESV, EXT (2WD, 4WD)	07-15	4108	C-R	Y	1	6003
Escalade, ESV, EXT (2WD, 4WD) (with Autoride suspension)	08-14	4186	C-R	Y	1	6015
Escalade, ESV, EXT (2WD, 4WD)	02-06	4108	C-R	Y	1	6003
Seville	80-85	4106	C-R	Y	1	6015
STS	06-14	4168	C-R	Y	1	6027
Chevrolet Cars						
Aveo	10	4103	C-R	Y	1	6014
Beretta, Corsica	88-96	4104	C-R	Y	1	6012
Camaro, Z-28, IROC-Z	82-02	4103	C-R	Y	1	6014
Cavalier	82-94	4104	C-R	Y	1	6012
Celebrity	82-90	4103	C-R	Y	1	6014
Chevelle	73-83	4114	C-R	Y	1	6008
El Camino	67-87	4114	C-R	Y	1	6008
Malibu	73-83	4114	C-R	Y	1	6008
Monte Carlo (not SS)	73-88	4114	C-R	Y	1	6008
Volt	12-14	4118	C-R	Y	1	6118



Model	Year	Air Leveling Rear				
		Rear Kit	Type			Air Spring
Chevrolet/GMC Vans						
Astro, Safari (2WD, AWD)	99-05	2361	R-R		2	6397
G1500 (6 lug nuts, GVWR 7200)	03-09	2423	R-R		2	6868
G1500, G2500 (6 lug nuts)	96-02	-2163- +++	S-R		2	9001
G10, G20, G30, G1500, G2500, G3500	70-95	0830	R-R		3	6859
G2500 G3500 (8 lug nuts) (Over 8600 GVW) (single rear wheel)	03-15	2337	S-R		2	9000
Lumina APV	90-96	-4110-	C-R	Y	1	6015
Uplander	05-09	4155	C-R	Y	1	6020
Chevrolet/GMC SUVs						
Avalanche 1500 (2WD, 4WD) (with Autoride suspension)	11-13	4186	C-R	Y	1	6015
Avalanche 1500 (2WD, 4WD)	02-13	4108	C-R	Y		6003
Blazer (2WD only) (full size)	73-91					
Denali XL 2500 (2WD, 4WD)	00-09	2253	R-R		2	6781
Envoy (2WD, 4WD) (with rear coil springs)	02-09	4108	C-R	Y	1	6003
Jimmy (2WD only) (full size)	73-91					
Suburban 1500 (2WD, 4WD)	07-15	4108	C-R	Y	1	6003
Suburban 1500 (2WD, 4WD) (with Autoride suspension)	08-14	4186	C-R	Y	1	6015
Suburban 1500 (2WD, 4WD)	00-06	4108	C-R	Y	1	6003
Suburban 1500 (2WD, 4WD)	92-99	2101	R-R		2	6781
Suburban 1500 (2WD only)	73-91	2100	R-R		2	6781
Suburban 1500 (4WD only)	73-91	2100	R-R		2	6781
Suburban 2500 (2WD, 4WD)	00-09	2253	R-R		2	6781
Suburban 2500 (2WD, 4WD)	92-99	2101	R-R		2	6781
Suburban 2500 (2WD only)	73-91	2100	R-R		2	6781
Suburban 2500 (4WD only)	73-91	2100	R-R		2	6781
Tahoe (2WD, 4WD)	00-15	4108	C-R	Y	1	6003
Tahoe (2WD, 4WD) (with Autoride suspension)	08-14	4186	C-R	Y	1	6015
Police Tahoe (2WD, 4WD)	07-10	4147	C-R	Y	1	6024
Tahoe (2WD, 4WD) (4-door only)	95-99	2101	R-R		2	6781
Trailblazer (2WD, 4WD)	02-09	4108	C-R	Y	1	6003
Yukon 1500 (2WD, 4WD)	07-15	4108	C-R	Y	1	6003
Yukon 1500 (2WD, 4WD) (with Autoride suspension)	08-14	4186	C-R	Y	1	6015
Yukon 1500 (2WD, 4WD)	00-06	4108	C-R	Y	1	6003
Yukon 1500 (2WD, 4WD) (4-door only)	95-99	2101	R-R		2	6781
Yukon XL 2500 (2WD, 4WD)	00-09	2253	R-R		2	6781
Yukon 2500 (2WD, 4WD) (4-door only)	95-99	2101	R-R		2	6781
Chevrolet/GMC Pickup Trucks						
S10 Crew Cab (2WD only)	04	2209	S-R		2	9001
S10, Sonoma (2WD only) (not factory lowered ZQ8)	82-03	2209	S-R		2	9001
Colorado, Canyon (2WD, 4WD) (not factory lowered ZQ8)	04-12	2384	R-R	Y	1.5	6397



		Air Leveling Rear						
Model	Year	Rear Kit	Type			Air Spring		
Chevrolet Silverado/GMC Sierra 1500								
Silverado, Sierra 1500 (2WD, 4WD)	07-15	2430	R-R	Y	1	6397		
Silverado Classic, Sierra Classic 1500 (2WD, 4WD)	07	2320 ++	S-R		2	9000		
Silverado, Sierra 1500 (2WD only) (not HD)	99-06	2320 ++	S-R		2	9000		
Silverado, Sierra 1500 (4WD only) (not HD)	99-06	2320 ++	S-R		2	9000		
Silverado, Sierra 1500HD (2WD, 4WD) (not Quad-Steer)	05-06	2190	R-R		2	6781		
Silverado, Sierra 1500HD (2WD, 4WD) (not Quad-Steer)	01-03	2190	R-R		2	6781		
C & K1500 (2WD, 4WD)	88-98	2025	R-R		2	6781		
C & K1500 (2WD only)	88-98	2162 ***	S-R		2	9002		
C & R 10, 1500 (2WD only)	73-87	2071 *	R-R		2	6781		
K & V-10, 1500 (4WD only)	73-87	2040 ***	R-R		2	6873		
Chevrolet Silverado/GMC Sierra 2500								
Silverado, Sierra 2500HD (2WD, 4WD)	11-15	2528	R-R	Y	1.5	6401		
Silverado, Sierra 2500HD (2WD only)	01-10	2250	R-R	Y	1.5	6781		
Silverado, Sierra 2500HD (4WD only)	01-10	2250	R-R	Y	1.5	6781		
Silverado, Sierra C2500 (2WD only) (not HD)	99-05	2190	R-R		2	6781		
Silverado, Sierra C2500 (4WD only) (not HD)	99-05	2190	R-R		2	6781		
C & K2500 (2WD, 4WD) (with rear drum brakes)	99-00	2025	R-R		2	6781		
C & K2500 (2WD, 4WD)	88-98	2025	R-R		2	6781		
C & R20 (2WD only)	73-87	2071 *	R-R		2	6781		
K & V20, 2500 (4WD only)	73-87	2040 ***	R-R		2	6873		
Chevrolet Silverado/GMC Sierra 3500								
Silverado, Sierra 3500HD (2WD, 4WD)	11-15	2528	R-R	Y	1.5	6401		
Silverado, Sierra 3500HD (2WD, only)	01-10	2250	R-R	Y	1.5	6781		
Silverado, Sierra 3500HD (4WD only)	01-10	2250	R-R	Y	1.5	6781		
C & K3500 (2WD, 4WD)	88-00	2025	R-R		2	6781		
C & R30, C & R3500 (2WD only)	73-87	2071 *	R-R		2	6781		
C30 (2WD only)	67-87	2071 *	R-R		2	6781		
K & V30, 3500 (4WD only)	73-87	2040 ***	R-R		2	6873		
Chevrolet/GMC Commercial Vehicles (vehicles without factory bed)								
C3500HD (2WD, 4WD), (wide track only)	11-12	2176 +	R-R		2	6781		
C2500HD, C3500HD (2WD, 4WD)	01-10	2249	R-R	Y	1.5	6781		
C3500 (Type I ambulance chassis)	88-00	-2065- ***	R-R		2	0335		
C4500, C5500 (2WD only)	02-09	2362 *	R-R		2	6781		
G3500, G4500 (with dual rear wheels)	98-13	2173	R-R	Y	2	6762		
G30, G3500	70-95	0830	R-R		3	6859		
Chevrolet/GMC Motorhomes Class "C" Vans								
G3500, G4500 (with dual rear wheels)	13-15	2557	R-R	Y	2	6766		
G3500, G4500 (with dual rear wheels)	98-12	2173	R-R	Y	2	6762		
G30, G3500	70-95	0830	R-R		3	6859		



Model	Year	Air Leveling Rear					Air Spring
		Rear Kit	Type				
Chevrolet/GMC Motorhomes Class "A" & Step Vans							
GP30 HD (cutaway) (10,500 to 12,300 GVWR)	93-96	2080	R-R	Y	2	6859	
GP30 HD (cutaway) (14,500 GVWR)	93-96	2085	R-R	Y	2	0335	
P30 (10,500 to 12,800 GVWR) (with jounce bumpers mounted at bottom of frame rails)	93-96	2080	R-R	Y	2	6859	
P30 (14,500 to 17,000 GVWR) (with jounce bumpers mounted above leaf springs)	93-99	2085	R-R	Y	2	0335	
P30 (with jounce bumpers mounted at bottom of frame rails)	63-92	2080	R-R	Y	2	6859	
Chrysler Cars / Vans / SUV							
Aspen (2WD, 4WD)	07-09	4152	C-R	Y	1	6009	
Imperial, New Yorker 5th Ave. Landau and Salon	90-94	4105	C-R	Y	1	6013	
Le Baron, GTS, TC By Maserati	82-95	4105	C-R	Y	1	6013	
New Yorker	84-89	4105	C-R	Y	1	6013	
Town and Country	08-15	4169	C-R		1	6013	
Town and Country	96-07	1005	L-R	Y	2	7217	
Town and Country (sw only)	84-89	4105	C-R	Y	1	6013	
Dodge Cars							
400, 600, Lancer, Daytona	82-94	4105	C-R	Y	1	6013	
Aries	81-89	4105	C-R	Y	1	6013	
Dart	12-15	4178	C-R	Y	1	6014	
Dynasty, Spirit	90-94	4105	C-R	Y	1	6013	
Shadow	87-94	4105	C-R	Y	1	6013	
Dodge Vans (See "Ram" for 2013 and up)							
Caravan, Grand Caravan	08-15	4169	C-R		1	6013	
Caravan, Grand Caravan	96-07	1005	L-R	Y	2	7217	
Sprinter 2500	03-06	2312 +++	S-R		2	9002	
Sprinter 3500	03-06	-2425-	R-R		2	6781	
B100, B150, B200, B250, B300, B350, 1500, 2500, 3500, MB300, MB400	77-03	2109	R-R	Y	1.5	6781	
B100, B200, B300	71-76	0830	R-R		3	6859	
Dodge SUVs							
Nitro (2WD, 4WD)	07-08	4146	C-R		1	6005	
Durango (2WD, 4WD)	11-15	4184	C-R	Y	1	6014	
Durango (2WD, 4WD)	04-09	4152	C-R	Y	1	6009	
Durango (2WD, 4WD) (not SXT)	97-02	2222	S-R	Y	1	9002	
Dodge Pickup Trucks (see "Ram" for Ram Trucks)							
Dakota Club Cab (2WD, 4WD)	05-11	2378 +++	S-R		2	9000	
Dakota Quad Cab (2WD, 4WD)	05-11	2379 +++	S-R		2	9000	
Dakota Standard & Crew Cab (2WD only)	97-02	2169 +++	S-R		2	9000	
Dakota (4WD only) (not crew cab)	97-03	2162 +++	S-R		2	9002	
Dakota Crew Cab (4WD only)	00-03	2217 +++	S-R		2	9000	
D & W 100, 150	69-93	2071 *	R-R		2	6781	
D & W 200, 250	69-93	2071 *	R-R		2	6781	
D & W 300, 350	69-93	2071 *	R-R		2	6781	



Model	Year	Air Leveling Rear					Air Spring
		Rear Kit	Type				
Dodge Commercial Vehicles (vehicles without factory bed)							
D3500, W3500 (2WD, 4WD) (cab & chassis)	94-02	2220	R-R	Y	2	6781	
Sprinter 2500 (cab & chassis)	02-06	2312 +++	S-R		2	9002	
Sprinter 3500 (cab & chassis)	02-06	2382	R-R		2	6397	
Dodge Motorhomes Class "C" Vans							
Sprinter 2500 (van and cab & chassis)	03-06	2312 +++	S-R	Y	1.5	9002	
Sprinter 3500 (cab & chassis)	03-06	2382	R-R		2	6781	
B100, B150, B200, B250, B300, B350, 1500, 2500, 3500, MB300, MB400	77-03	2109	R-R	Y	1.5	6781	
B100, B200, B300	71-76	0830	R-R		3	6859	
Ford Cars							
Country Squire	83-97	4108	C-R	Y	1	6003	
Crown Victoria (with rear coil springs)	98-08	4107	C-R	Y	1	6021	
Crown Victoria	83-97	4108	C-R	Y	1	6003	
Fusion	13-15	4145	C-R	Y	1	6028	
Fusion	06-12	4169	C-R		1.5	6013	
LTD	83-86	4103	C-R	Y	1	6014	
Mustang	79-03	4103	C-R	Y	1	6014	
Taurus	10-15	4177	C-R	Y	1	6015	
Taurus (sw only)	86-98	4105	C-R	Y	1	6013	
Thunderbird	92-97	4105	C-R	Y	1	6013	
Thunderbird	89-91	4104	C-R	Y	1	6012	
Thunderbird	80-88	4106	C-R	Y	1	6015	
Ford Vans							
Transit Connect	10-13	2485	R-R	Y	1.5	6762	
Freestar	04-07	4151	C-R	Y	1	6016	
Windstar	98-03	4106	C-R	Y	1	6015	
E150	08-14	2488	R-R	Y	1.5	6764	
E150	75-07	2171	S-R		2	7076	
E100, E150 (may require tailpipe modification)	75-91	2032	R-R	Y	1.5	6859	
E250	98-14	2165	S-R		2	9002	
E250 (may require tailpipe modification)	75-91	2032	R-R	Y	1.5	6859	
E350 (with single rear wheels)	98-14	2181	S-R		2	9000	
E350 (may require tailpipe modification)	75-91	2032	R-R	Y	1.5	6859	
Ford CUVs							
Edge	07-10	4171	C-R	Y	1	6020	
Escape (2WD, 4WD)	13-14	4158	C-R	Y	1	6026	
Flex	09-13	4177	C-R	Y	1	6026	



Model	Year	Air Leveling Rear					Air Spring
		Rear Kit	Type				
Ford SUVs							
Bronco (4WD only) (full size)	90-96	2071 *	R-R			2	6781
Bronco (2WD, 4WD)	80-90						
Excursion (2WD only)	00-06	2255	R-R	Y		2	6781
Excursion (4WD only)	00-06	2251	R-R	Y		2	6781
Expedition (2WD, 4WD) (with rear coil springs)	97-02	4134	C-R	Y		1	6022
Explorer	11-15	4189	C-R			1.5	6026
Ford Pickup Trucks							
Ranger (2WD, 4WD) (not for use with composite leaf) (not SuperCab 4WD with 6' bed)	83-11	2531+++	S-R			2	9000
F100 (2WD, 4WD)	68-79	2071*	R-R			2	6781
Ford F150							
F150 (2WD, 4WD)	15	2582	R-R	Y		1.5	6781
F150 (2WD, 4WD) (Not Raptor or FX2)	09-14	2525+	R-R	Y		1.5	6781
F150 (2WD, 4WD) (with B&W hitch only)	09-14	2542+	R-R	Y		1.5	6781
F150 Raptor (4WD only)	09-14	2565+	R-R	Y		1.5	9055
F150 (2WD, 4WD) (not FX2)	04-08	2350#	R-R	Y		1.5	6397
F150, F150 Heritage (2WD, 4WD)	97-04	2320++	S-R			2	9000
F150 (2WD, 4WD)	68-96	2071*	R-R			2	6781
Ford F250							
F250 Under 8500 GVWR (2WD, 4WD)	97-03	2320++	S-R			2	9000
F250 Under 8500 GVWR (2WD only)	69-96	2071*	R-R			2	6781
F250 Under 8500 GVWR (4WD only)	69-96	2071*	R-R			2	6781
F250 (2WD only) Diesel	11-15	2535	R-R	Y		2	6401
F250 (2WD only) gasoline	11-15	2550	R-R	Y		1.5	6401
F250 (2WD only)	08-10	2550	R-R	Y		1.5	6401
F250 (2WD only)	05-07	2398	R-R			2	6401
F250 Over 8500 GVWR (2WD only)	99-04	2550	R-R	Y		1.5	6401
F250 Over 8500 GVWR (2WD only)	84-98	2071*	R-R			2	6781
F250 Over 8500 GVWR (2WD only)	69-83	2071*	R-R			2	6781
F250 (4WD only), Diesel	11-15	2535	R-R	Y		2	6401
F250 (4WD only), Gasoline	11-15	2550	R-R	Y		1.5	6401
F250 (4WD only)	08-10	2550	R-R	Y		1.5	6401
F250 (4WD only)	05-07	2400	R-R	Y		1.5	6401
F250 Over 8500 GVWR (4WD only)	99-04	2550	R-R	Y		1.5	6401
F250 Over 8500 GVWR (4WD only)	69-83	2071 *	R-R			2	6781



		Air Leveling Rear						
Model	Year	Rear Kit	Type			Air Spring		
Ford F350								
F350 (2WD only) Diesel	11-15	2535	R-R	Y	1.5	6401		
F350 (2WD only) Gasoline (not V10 gas w/extended cab and 8' bed)	11-15	2550	R-R	Y	1.5	6401		
F350 (2WD only)	08-10	2550	R-R	Y	1.5	6401		
F350 (2WD only)	06-07	2398	R-R	Y	1.5	6401		
F350 (2WD only)	05	2398	R-R	Y	1.5	6401		
F350 (2WD only) (not V10 gas w/extended cab and 8' bed)	99-04	2550	R-R	Y	1.5	6401		
F350 (2WD only)	70-98	2071 *	R-R		2	6781		
F350 (2WD only)	63-69	2071 *	R-R		2	6781		
F350 (4WD only) Diesel	11-15	2535	R-R	Y	1.5	6401		
F350 (4WD only) Gasoline	11-15	2550	R-R	Y	1.5	6401		
F350 (4WD only)	08-10	2550	R-R	Y	1.5	6401		
F350 (4WD only)	05-07	2400	R-R	Y	1.5	6401		
F350 (4WD only)	99-04	2550	R-R	Y	1.5	6401		
F350 (4WD only)	84-98	2071 *	R-R		2	6781		
F350 (4WD only)	63-83	2071 *	R-R		2	6781		
Ford F450								
F450 (2WD only)	15	2442	R-R		2	7689		
F450 (2WD only)	11-14	2535	R-R	Y	1.5	6401		
F450 (2WD only)	08-10	2446	R-R		2	7701		
F450 (4WD only)	15	2442			1.5	7689		
F450 (4WD only)	11-14	2535	R-R	Y	1.5	6401		
F450 (4WD only)	08-10	2446	R-R		2	7701		
Ford Commercial Vehicles (vehicles without factory bed)								
E250 (cutaway)	07-08	2061	R-R	Y	1.5	6764		
E350 (with dual rear wheels)	92-14	2061	R-R	Y	1.5	6764		
E350 (may require tailpipe modification)	75-91	2032	R-R	Y	1.5	6859		
E450	08-14	2458	R-R	Y	1.5	6397		
E450	96-07	2377	R-R	Y	1.5	6397		
E450 (requires 2" clearance above frame)	96-14	2153 +	R-R		2	6781		
F350 (2WD, 4WD)	05-08	2176 *	R-R		2	6781		
F350 (2WD only)	99-04	2176 *	R-R		2	6781		
F350 (4WD only)	99-04	2176 *	R-R		2	6781		



Air Leveling Front						Work-Rite						Suggested Air Accessory
Front Kit	Type			Air Spring	Rear Kit			Front Kit				
4101	C-R	Y	1	6102	8615	Y	1	8616	Y	1	Heavy Duty	
4101	C-R	Y	1	6102	8615	Y	1	8616	Y	1	Heavy Duty	
4101	C-R	Y	1	6102	8615	Y	1	8616	Y	1	Heavy Duty	
4101	C-R	Y	1	6102	8615	Y	1	8616	Y	1	Heavy Duty	
4160 or 4187 if snow plow prep	C-R	Y	1	6125 / 6119	8615	Y	1	8616 not for snow plow prep	Y	1	Heavy Duty	
4101	C-R	Y	1	6102	8613	Y	1		Y	1	Heavy Duty	
4101	C-R	Y	1	6102							Heavy Duty	
											Heavy Duty	
4160 or 4187 if snow plow prep	C-R	Y	1	6125 / 6119	8615	Y	1	8616 not for snow plow prep	Y	1	Heavy Duty	
4160 or 4187 if snow plow prep	C-R	Y	1	6125 / 6119	8615	Y	1	8616 not for snow plow prep	Y	1	Heavy Duty	
4160 or 4187 if snow plow prep	C-R	Y	1	6125 / 6119	8615	Y	1	8616 not for snow plow prep	Y	1	Heavy Duty	
4160 or 4187 if snow plow prep	C-R	Y	1	6125 / 6119	8615	Y	1	8616 not for snow plow prep	Y	1	Heavy Duty	
2223	R-R		2	6762	8613	Y	1				Heavy Duty	
2223	R-R		2	6762							Heavy Duty	
											Heavy Duty	
4101	C-R	Y	1	6102								
4101	C-R	Y	1	6102							Heavy Duty	
4101	C-R	Y	1	6102							Heavy Duty	
4160		Y	1	6125								
4160	C-R	Y	1	6125							Heavy Duty	
4160	C-R	Y	1	6125							Heavy Duty	
4101	C-R	Y	1	6102							Heavy Duty	
4101	C-R	Y	1	6102	8618	Y	1				Heavy Duty	
4101	C-R	Y	1	6102							Heavy Duty	
4101	C-R	Y	1	6102							Heavy Duty	
4101	C-R	Y	1	6102							Heavy Duty	
4101	C-R	Y	1	6102							Heavy Duty	
4101	C-R	Y	1	6102							Heavy Duty	
4160	C-R	Y	1	6125	8630		2				Heavy Duty	
4101	C-R	Y	1	6102	8630		2				Heavy Duty	
2223	R-R		2	6762	8630		2				Heavy Duty	



Model	Year	Air Leveling Rear					Air Spring
		Rear Kit	Type				
Ford Commercial Vehicles (vehicles without factory bed) Continued							
F350 (Type I Ambulance Chassis)	80-97	-2065- ***	R-R			2	6859
F450 (2WD, 4WD)	05-15	2176 *	R-R			2	6781
F450 (2WD, 4WD)	99-04	2176 *	R-R			2	6781
F550 (2WD, 4WD) (requires 2" clearance above frame)	05-15	2404 ***	R-R			2	7714
F550 (2WD, 4WD) (requires 2" clearance above frame)	99-04	2404 ***	R-R			2	7714
F650	02-07						
LCF45, LCF55 (with side fuel tanks for rear kit) (rear kit does not fit 115" wb)	06-09	-2437-	R-R			2	5405
F59	11-12	2170 +	R-R			2	6781
Ford Motorhomes Class "C" Vans							
E350 (with dual rear wheels)	92-14	2061	R-R	Y		1.5	6764
E350 (may require tailpipe modification)	75-91	2032	R-R	Y		1.5	6859
E450	08-14	2458	R-R	Y		1.5	6397
E450	96-07	2377	R-R	Y		1.5	6397
E450 (requires 2" clearance above frame)	96-14	2153 +	R-R			2	6781
Ford Motorhomes Class "A"							
E33 (with front coil springs)	92-96	2061	R-R	Y		1.5	6764
E33 (with front coil springs)	86-91	2032	R-R	Y		1.5	6859
F53 (24,000, 26,000 GVWR) (not Thor m/h)	08-14	2474 +	R-R			2	6781
F53 (16,000 to 22,000 GVWR) (not Thor m/h)	08-12	2170 +	R-R			2	6781
F53 (16,000 to 22,000 GVWR) (not Thor m/h)	99-07	2170 +	R-R			2	6781
F53	90-98	2068 +	R-R			2	0335
Freightliner Vans							
Sprinter 2500	02-06	2312+++	S-R			2	9002
Sprinter 3500 (cab & chassis)	02-06	2382	R-R			2	6781
Freightliner / Oshkosh / John Deere Motorhomes Class "A"							
"M" and "X" chassis (not XC21) (below 22,000 GVWR)	94-98	2071 *	R-R			2	6781
Honda Cars / Vans / SUVs							
CR-Z	11-14	4183	C-R	Y		1	6027
Fit	10-14	4183	C-R	Y		1	6027
Insight	10-14	4183	C-R	Y		1	6027
Odyssey	05-10	4179	C-R			1.5	6020
Odyssey	99-04	4138	C-R			1.5	6017
Passport (2WD, 4WD)	98-02	4136	C-R	Y		1	6014
Pilot	05-10	4179	C-R			1.5	6020
Pilot	03-04	4138	C-R	Y		1	6017
Hummer SUVs							
H2, H2 SUT (with rear coil springs)	07-09	4108	C-R	Y		1	6003
H2, H2 SUT (with rear coil springs)	03-06	4108	C-R	Y		1	6003



Model	Year	Air Leveling Rear					Air Spring
		Rear Kit	Type				
Hyundai Car / Van / SUVs							
Accent	07-13	4136	C-R	Y	1	6014	
Entourage	07-09	4138	C-R		1.5	6017	
Santa Fe	07-14	4170	C-R		1.5	6117	
Veracruz	07-12	4170	C-R		1	6117	
Infiniti SUVs							
FX45 (2WD, 4WD)	03-08	4118	C-R	Y	1	6118	
QX56	05-09	4150	C-R	Y	1	6023	
International Commercial Vehicle (vehicles without factory bed)							
Citystar CF 500, CF 600 (with side fuel tanks for rear kit) (rear kit does not fit 115" wb)	06-09	-2437-	R-R		2	5405	
Isuzu SUVs / Truck							
290i, 370i (2WD, 4WD)	06-09	2384	R-R	Y	1.5	6397	
Amigo	98-00	4103	C-R	Y	1	6014	
Axiom	02-03	4136	C-R	Y	1	6014	
Rodeo, Rodeo Sport	98-04	4136	C-R	Y	1	6014	
Trooper	92-97	4106	C-R	Y	1	6015	
Jeep SUVs							
Cherokee	14-15	4196	C-R	Y	1	6118	
Commander (2WD, 4WD)	06-10	4157	C-R	Y	1	6005	
Grand Cherokee (2WD, 4WD) (not "Overland")	11-15	4184	C-R	Y	1	6014	
Grand Cherokee (2WD, 4WD)	05-10	4157	C-R		1.5	6005	
Grand Cherokee (2WD, 4WD) (not "up country")	92-98	4118	C-R	Y	1	6118	
Grand Wagoneer (2WD, 4WD)	92-98	4118	C-R	Y	1	6118	
Liberty (2WD, 4WD)	08-12	4170	C-R		1.5	6017	
Liberty (2WD, 4WD)	02-07	4146	C-R		1.5	6005	
Summit (sw only)	92-93	4105	C-R	Y	1	6013	
Wrangler (except Rubicon) (2WD, 4WD)	07-15	4173	C-R	Y	1	6106	
Wrangler Rubicon (4WD only)	07-15	4172	C-R	Y	1	6107	
Wrangler Unlimited (except Rubicon) (2WD, 4WD)	07-15	4173	C-R	Y	1	6106	
Wrangler Unlimited Rubicon (4WD only)	07-15	4172	C-R	Y	1	6107	
Wrangler (2WD, 4WD)	97-06	4157	C-R		1.5	6005	
Kia Van / SUV							
Sedona	06-14	4138	C-R		1.5	6017	
Sorento	03-10	4153	C-R	Y	1	6024	
Land Rover SUVs							
Defender 90	90-97	4121	C-R	Y	1	6003	
Discovery (with rear coil springs)	90-04	4121	C-R	Y	1	6003	
Range Rover	90-96	4121	C-R	Y	1	6003	



Model	Year	Air Leveling Rear					Air Spring
		Rear Kit	Type				
Lexus SUVs							
LX 450	96-98	4124	C-R	Y	1	6007	
LX 470	99-07	4124	C-R	Y	1	6007	
LX 570	13-14	4135	C-R	Y	2	6024	
LX 570	09-12	4164	C-R	Y	2	6009	
Lincoln Cars / CUVs / Truck							
Continental (with rear coil springs)	82-88	4106	C-R	Y	1	6015	
Mark IV (with rear coil springs)	84-87	4106	C-R	Y	1	6015	
Mark LT (2WD, 4WD)	09	2525 +	R-R	Y	1.5	6781	
Mark LT (2WD, 4WD)	05-08	2350	R-R	Y	1.5	6397	
MKS	09-14	4178	C-R	Y	1	6014	
MKT	09-13	4178	C-R	Y	1	6014	
MKX	07-11	4171	C-R	Y	3.5	6020	
MKZ	11-14	4170	C-R	Y	1	6017	
Towncar	80-89	4108	C-R	Y	1	6003	
Mazda Car / Van / CUVs / Truck							
CX5	12-14	4178	C-R	Y	1	6014	
CX7	07-12	4167	C-R	Y	1	6027	
Mazda5	06-13	4168	C-R	Y	1	6027	
MPV	96-98	4105	C-R	Y	1	6013	
Pickup (2WD only)	72-90	1130 **	R-R	Y	1.5	6873	
Mercury Cars / Van							
Capri	79-86	4103	C-R	Y	1	6014	
Colony Park	83-97	4108	C-R	Y	1	6003	
Cougar	92-97	4105	C-R	Y	1	6013	
Cougar	89-91	4104	C-R	Y	1	6012	
Cougar	80-88	4106	C-R	Y	1	6015	
Grand Marquis	98-08	4107	C-R	Y	1	6021	
Grand Marquis	83-97	4108	C-R	Y	1	6003	
Marquis	83-86	4103	C-R	Y	1	6014	
Milan	06-08	4168	C-R	Y	1	6027	
Monterey	04-07	4151	C-R	Y	1	6016	
Sable (sw only)	86-98	4105	C-R	Y	1	6013	
Mitsubishi SUVs							
Expo (2WD, 4WD)	92-93	4105	C-R	Y	1	6013	
Outlander	12	4182	C-R	Y	1	6026	
Outlander	07-09	4182	C-R	Y	1	6026	
Mitsubishi Pickup Trucks							
Raider Extended Cab (2WD, 4WD)	06-09	2378 +++	S-R		2	9000	
Raider Double Cab (2WD, 4WD)	06-09	2379 +++	S-R		2	9000	
Pickup (2WD only)	69-96	1130 **	R-R	Y	1.5	6873	



Model	Year	Air Leveling Rear					Air Spring
		Rear Kit	Type				
Nissan Cars							
Altima	05-15	4105	C-R	Y	1	6013	
Maxima	05-08	4105	C-R	Y	1	6013	
Nissan Vans							
NV1500, NV2500	12-14	2551	R-R	Y	1.5	6766	
Quest	12-14	4188	C-R	Y	1	6028	
Quest	04-09	4118	C-R	Y	1	6118	
Nissan SUVs							
Armada (2WD, 4WD)	06-14	4150	C-R	Y	1	6023	
Murano (2WD, 4WD)	09-14	4181	C-R	Y	1	6024	
Murano (2WD, 4WD)	03-08	4118	C-R	Y	1	6018	
Pathfinder (2WD, 4WD)	13-14	4118	C-R	Y	1	6018	
Pathfinder (2WD, 4WD)	06-12	4166	C-R	Y	1	6021	
Pathfinder Armada (2WD, 4WD)	04-05	4150	C-R	Y	1	6023	
Pathfinder (2WD, 4WD)	87-95	4106	C-R	Y	1	6015	
Rogue (2WD, 4WD)	08-14	4181	C-R	Y	1	6024	
Xterra (2WD, 4WD)	05-14	2409	S-R	Y	1.5	9002	
Nissan Pickup Trucks							
Frontier (2WD, 4WD)	05-14	2558	R-R	Y	1.5	6766	
Frontier (2WD only)	01-04	2293	S-R	Y	1.5	9002	
Pickup (2WD only)	69-96	1130 **	R-R	Y	1.5	6873	
Titan (2WD, 4WD)	04-14	2355	R-R	Y	1.5	6781	
Oldsmobile Cars / Van / SUV							
Achieva	92-98	4104	C-R	Y	1	6012	
Aurora	95-04	4105	C-R	Y	1	6013	
Bravada (2WD, 4WD) (with rear coil springs)	02-05	4106	C-R	Y	1	6015	
Calais, Cutlass, Cutlass Supreme (not sw)	73-87	4114	C-R	Y	1	6008	
Cutlass Calais (fwd only)	85-91	4104	C-R	Y	1	6012	
Cutlass Cierra	82-96	4103	C-R	Y	1	6014	
Cutlass Cruiser (sw only) (fwd only)	84-95	4103	C-R	Y	1	6014	
Delta 88, 98 (fwd only)	85-99	4107	C-R	Y	1	6021	
Firenza (fwd only)	82-88	4104	C-R	Y	1	6012	
LSS	96-01	4107	C-R	Y	1	6021	
Silhouette	90-96	-4110-	C-R	Y	1	6015	
Toronado	79-85	4106	C-R	Y	1	6015	
Plymouth Cars / Truck							
Acclaim	89-95	4105	C-R	Y	1	6013	
Arrow	80-93	1130 **	R-R	Y	1.5	6873	
Caravelle	85-88	4105	C-R	Y	1	6013	
Reliant	81-94	4105	C-R	Y	1	6013	
Sundance	87-93	4105	C-R	Y	1	6013	



		Air Leveling Rear					
Model	Year	Rear Kit	Type			Air Spring	
Pontiac Cars / Van / SUV							
6000	82-91	4103	C-R	Y	1	6014	
Bonneville (fwd only)	00-05	4105	C-R	Y	1	6013	
Bonneville (fwd only)	87-99	4107	C-R	Y	1	6021	
Firebird, Trans Am	82-02	4103	C-R	Y	1	6014	
Grand Am	85-97	4104	C-R	Y	1	6012	
Grand Prix	73-87	4114	C-R	Y	1	6008	
Grand Prix	65-68	4114	C-R	Y	1	6008	
J-2000, Sunbird	82-94	4104	C-R	Y	1	6012	
Le Mans	88-92	4104	C-R	Y	1	6012	
Transport APV	90-96	-4110-	C-R	Y	1	6015	
Ram Van							
C/V	08-14	4192	C-R		1	6028	
Ram Pickup Trucks							
Dakota Club Cab (2WD, 4WD)	05-11	2378+++	S-R		2	9000	
Dakota Quad Cab (2WD, 4WD)	05-11	2379+++	S-R		2	9000	
Ram 50	80-93	1130 **	R-R	Y	2	6873	
Ram 1500							
Ram 1500 (2WD, 4WD) (not Power Ram)	09-13	2518	AC	Y	4	9047	
Ram 1500 (2WD, 4WD) (not Power Ram)	09-13	4190	C-R	Y	1	6130	
Ram 1500 (2WD, 4WD)	02-08	2286	R-R	Y	1.5	6781	
Ram 1500 Mega Cab (2WD only)	06-08	2299	R-R	Y	1.5	6401	
Ram 1500 Mega Cab (4WD only)	06-08	2299	R-R	Y	1.5	6401	
Ram 1500 (2WD only)	94-01	2071 *	R-R		2	6781	
Ram 1500 (2WD only)	94-01	2162 +++	R-R		2	9002	
Ram 1500 (4WD only)	94-01	2071 *	R-R		2	6781	
Ram 1500 (2WD, 4WD)	69-93	2071 *	R-R		2	6781	
Ram 2500							
Ram 2500 (4WD only)	14-15	2580	R-R	Y	1.5	6873	
Ram 2500 (2WD, 4WD)	13	2299	R-R	Y	1.5	6401	
Ram 2500 (2WD only)	03-12	2299	R-R	Y	1.5	6401	
Ram 2500 (4WD only)	03-12	2299	R-R	Y	1.5	6401	
Ram 2500 (2WD only)	94-02	2071 *	R-R		2	6781	
Ram 2500 (4WD only)	94-02	2071 *	R-R		2	6781	
Ram 2500 (2WD, 4WD) (with contact overload springs)	94-98	2220	R-R	Y	2	6781	
Ram 2500 (2WD, 4WD)	69-93	2071 *	R-R		2	6781	



		Air Leveling Rear						
Model	Year	Rear Kit	Type			Air Spring		
Ram 3500								
Ram 3500 (2WD only)	14	2579	R-R	Y	1.5	6401		
Ram 3500 (4WD only)	13-14	2560	R-R	Y	1.5	6401		
Ram 3500 (2WD only)	03-12	2299	R-R	Y	1.5	6401		
Ram 3500 (4WD only)	03-12	2299	R-R	Y	1.5	6401		
Ram 3500 (2WD only)	94-02	2071 *	R-R		2	6781		
Ram 3500 (4WD only)	94-02	2071 *	R-R		2	6781		
Ram 3500 (2WD, 4WD)	69-93	2071 *	R-R		2	6781		
Ram Commercial Vehicles (vehicles without factory bed)								
Ram 3500 HD (2WD, 4WD) (cab & chassis)	07-14	2478 +	R-R		2	6781		
Ram 4500, 5500 (2WD, 4WD) (requires 2" clearance above frame)	07-14	2404 ***	R-R		2	7714		
Ram 2500 (2WD, 4WD) (not dually, with box delete)	04-08	2299	R-R	Y	1.5	6401		
Ram 3500 (4WD only) (dually only, with box delete)	06-12	2299	R-R	Y	1.5	6401		
Ram 3500 HD (2WD, 4WD) (cab & chassis)	07-13	2478 +	R-R		1.5	6781		
Ram 4500, 5500 (2WD, 4WD) (requires 2" clearance above frame)	07-13	2404 ***	R-R		2	7714		
Saturn Van								
Relay	05-07	4155	C-R	Y	1	6020		
Scion Cars								
iQ	12-14	4178	C-R	Y	1	6014		
xA	04-07	4136	C-R	Y	1	6014		
xB	08-14	4136	C-R	Y	1	6014		
xD	08-14	4156	C-R	Y	1	6015		
Sterling Commercial Vehicles (vehicles without factory bed)								
Bullet (2WD, 4WD) (cab & chassis)	08-09	2478 +	R-R		2	6781		
Toyota Cars								
ECHO	01-05	4118	C-R	Y	1	6118		
Prius	10-15	4136	C-R	Y	1	6014		
Yaris	07-14	4136	C-R	Y	1	6014		
Toyota Vans								
Sienna (not AWD)	04-14	4155	C-R	Y	1	6020		
Sienna	98-03	4118	C-R	Y	1	6118		
Van (with rear coil springs)	64-89	4112	C-R	Y	1	6006		
Toyota SUVs								
RAV4 (2WD, 4WD)	07-14	4174	C-R	Y	1	6028		
RAV4 (2WD, 4WD)	96-98	4104	C-R	Y	1	6012		
FJ Cruiser	07-14	4135	C-R	Y	2	6024		
4Runner	98-13	4135	C-R	Y	2	6024		
4Runner	96-97	4123	C-R	Y	2	6021		
4Runner	90-95	4112	C-R	Y	1	6006		
Sequoia (with rear coil springs)	08-14	4164	C-R	Y	1	6009		
Sequoia	01-07	4124	C-R	Y	1	6007		



Model	Year	Air Leveling Rear					Air Spring
		Rear Kit	Type				
Toyota SUVs Continued							
Land Cruiser	08-14	4164	C-R	Y	2	6009	
Land Cruiser	91-07	4124	C-R	Y	1	6007	
Toyota Pickup Trucks							
Pickup (2WD only)	69-95	1130 **	R-R	Y	1.5	6873	
Pickup (4WD only)	84-95	-2116-	R-R	Y	1.5	6781	
T 100 (4WD only)	93-98	-2116-	R-R	Y	1.5	6781	
Tacoma (2WD only)	05-15	2410	R-R	Y	1.5	6762	
Tacoma (2WD only)	95-04	2213	R-R		2	6762	
Tacoma Prerunner (2WD only)	05-15	2407	R-R	Y	1.5	6766	
Tacoma Prerunner (2WD only)	95-04	2304 #	R-R		2	6781	
Tacoma (4WD only)	05-15	2407	R-R	Y	1.5	6766	
Tacoma (4WD only)	95-04	2304 #	R-R		2	6781	
Tundra (2WD, 4WD), TRD	07-15	2445	R-R	Y	1.5	6410	
Tundra (2WD only)	00-06	2212	S-R		2	9001	
Tundra TRD (2WD only)	00-06	2245	R-R		2	6781	
Tundra (4WD only)	00-06	2245	R-R		2	6781	
Volkswagen Cars							
CC	09-14	4176	C-R	Y	1	6027	
Beetle (not turbo)	12-14	4176	C-R	Y	1	6027	
Beetle Turbo	12-14	4175	C-R	Y	1	6026	
Eos	07-14	4176	C-R	Y	1	6027	
GTI	07-14	4176	C-R	Y	1	6027	
Golf	11-15	4176	C-R	Y	1	6027	
Golf TDI	11-15	4176	C-R	Y	1	6027	
Jetta	12-14	4176	C-R	Y	1	6027	
Jetta (not TDI)	07-10	4175	C-R	Y	1	6026	
Jetta Sport Wagen	12-13	4176	C-R	Y	1	6027	
Jetta Sport Wagen	09-10	4176	C-R	Y	1	6027	
Passat (not TDI)	12-15	4176	C-R	Y	1	6027	
Passat (not TDI)	98-06	4105	C-R	Y	1	6013	
Passat Wagen	07-09	4175	C-R	Y	1	6026	
Volkswagen Vans							
Routan	09-12	4169	C-R		1.5	6013	
Euro Van, T-4	85-03	4117	C-R	Y	1	6004	
Volkswagen SUV							
Tiguan	09-13	4176	C-R	Y	1	6027	
Workhorse Motorhomes Class "A"							
P30, P32, W16 10,500 to 17,000 GVWR	00-07	2085	R-R	Y	1.5	6781	
W20, W22, W24	04-09	2347	R-R		2	5405	
UFO	07-09	-2457-	R-R	Y	1.5	7689	



Lifted & Lowered

Lift spacers can be used with most Ride-Rite™ air helper spring kits - NOT Coil-Rite™ or Sport-Rite™ kits. The spacer needs to be the same length as the amount of lift applied to the axle on which the air helper spring is being installed.

Lifted Applications

Lift Spacers

	Distance Between Brackets	Block Size	Lift Spacer Number
	6.5" - 7.5"	1.25"	2536 (PACKAGES OF 2)
	7.5" - 8.5"	2"	2366 (PACKAGES OF 2)
	8.5" - 9.5"	3"	2367 (PACKAGES OF 2)
	9.5" - 10.5"	4"	2370 (PACKAGES OF 2)
	10.5" - 11.5"	5"	2372 (PACKAGES OF 2)
	11.5" - 12.5"	6"	2374 (PACKAGES OF 2)

Axle Extension Brackets for Lifted Vehicles

	SOME KITS / BRACKETS MAY REQUIRE DRILLING. USE THE EXTENSION BRACKET AS A TEMPLATE TO MARK AND DRILL THE HOLES.		Lift	Kit Number	Make/Model Number
	2"	2506	Tundra 07-14 2445		
	3"	2507			
	4"	2508			
	5"	2509			
	6"	2510			

The lowered vehicle applications come complete with the necessary brackets, air springs, fittings and inflation valves for manual inflation.

Lowered Applications

	Make/Model	Lowered	Year	Rear Kit	Air Spring
	Chevrolet C1500 (w/c notch & axle flip) (4x2 only)	2"- 4"	88-98	2252*	6762
	Chevrolet/GMC Blazer/Jimmy		82-02	2516 +++	9001
	Chevrolet S10		82-04		
	Toyota Tacoma		95-04		
	Dodge Ram 1500		69-01	2517	
	Ford F100, F150		70-03		
	Chevrolet C1500		88-98		
	Chevrolet C1500		99-06		

Minimum Tire to Frame Clearance Requirements: * = 7.50" , +++ = 6.50" • DO NOT EXCEED THE VEHICLE'S RECOMMENDED GROSS VEHICLE WEIGHT RATING (GVWR)

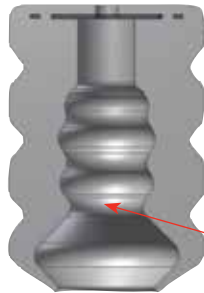

The hollow inside shape and external rib spacing allow for a smoother transition when the load increases and the suspension starts to compress.

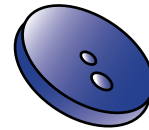

0013
Each Work-Rite kit includes spacers to allow adjustment of the suspension contact point.

Work-Rite	Color	Diameter	Length	Weight Capacity
1258	White	3.52"	5.17"	1000 lbs
1259	Gray	3.52"	5.17"	1200 lbs
1260	Black	3.52"	5.17"	1750 lbs
1261	Black - HD	3.52"	5.17"	2250 lbs
1263	Black	2.49"	2.66"	1750 lbs
1264	White	3.52"	3.69"	1000 lbs
1265	Gray	3.52"	3.69"	1200 lbs
1266	Black	3.52"	3.69"	1750 lbs

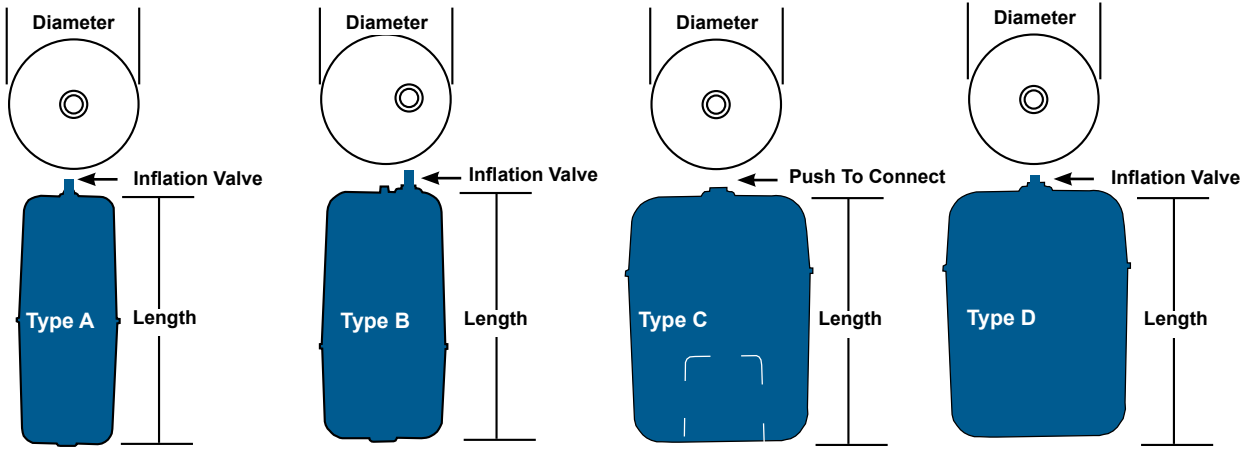

Coil-Rite Spring	Diameter	Length	Type
6003	4.75"	10.00"	C
6004	4.75"	6.50"	C
6005	5.50"	5.00"	C
6006	5.50"	7.00"	C
6007	5.50"	8.00"	C
6008	5.50"	9.00"	C
6009	5.50"	10.00"	C
6010	5.50"	11.00"	C
6012	4.00"	4.00"	C
6013	4.00"	5.00"	C
6014	4.00"	8.00"	C
6015	4.00"	9.00"	C
6016	4.00"	10.00"	C
6017	4.75"	4.00"	C
6018	4.00"	7.00"	C
6019	4.00"	12.00"	C
6020	4.75"	6.50"	C
6021	4.75"	9.00"	C
6022	4.75"	13.00"	C
6023	4.75"	12.00"	C
6024	4.75"	7.50"	C
6025	4.00"	11.00"	C
6026	3.56"	8.75"	C
6027	3.56"	7.00"	C
6028	4.00"	6.00"	C

Coil-Rite Spring	Diameter	Length	Type
6100	3.56"	10.50"	A
6102	4.00"	11.00"	B
6103	4.75"	10.00"	D
6104	4.75"	6.50"	D
6105	5.50"	5.00"	D
6106	5.50"	7.00"	D
6107	5.50"	8.00"	D
6108	5.50"	9.00"	D
6109	5.50"	10.00"	D
6110	5.50"	11.00"	D
6111	4.00"	8.00"	B
6112	4.00"	4.00"	D
6113	4.00"	5.00"	D
6114	4.00"	8.00"	D
6115	4.00"	9.00"	D
6116	4.00"	10.00"	D
6117	4.75"	4.00"	D
6118	4.00"	7.00"	D
6119	4.00"	12.00"	D
6120	4.75"	6.50"	D
6121	4.75"	9.00"	D
6122	4.75"	13.00"	D
6123	4.75"	12.00"	D
6124	4.75"	7.50"	D
6125	4.00"	11.00"	D
6128	4.00"	6.00"	D
6130	4.38"	11.00"	D



**Single
Convoluted**



**Double
Convoluted**



**Reversible
Sleeve**



**Reversible
Sleeve**



**Tapered
Sleeve**

Red Label™ High Pressure Air Springs - up to 150 PSI

Firestone continues to raise the bar on high pressure and high quality air springs with our **RED LABEL™** edition. The air spring operates up to 150 PSI and has a test pressure of 400 PSI. *The Red Label parts are not intended to supplement the standard air springs in the Ride-Rite kits. The Red Label parts are intended for use on custom applications only.*

267C 1.5



Compressed Height 2.80"
Extended Height 8.30"
Ride Height 5.50" - 6.50"
Max. Diameter 6.60"

224C



Compressed Height 3.00"
Extended Height 8.91"
Ride Height 5.50" - 7.00"
Max. Diameter 7.52"

7703

3/8 NPT

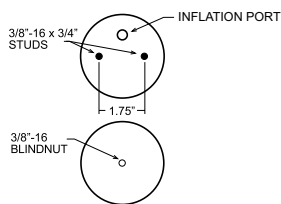

7671

1/2 NPT

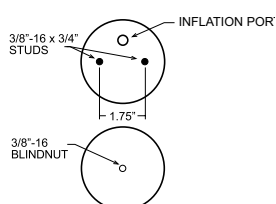

2800 lbs. per air spring*

7702

3/8 NPT

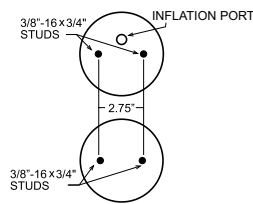

7668

1/2 NPT

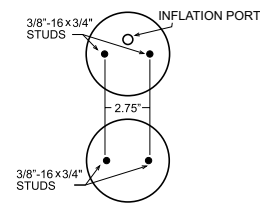

3250 lbs. per air spring*

1/8 NPT = 0.405" • 1/4 NPT = 0.540" • 3/8 NPT = 0.675" • 1/2 NPT = 0.840"



Standard Air Springs - up to 100 PSI

160BY



Compressed Height 3.00"
 Extended Height 6.50"
 Ride Height 5.00" - 6.00"
 Max. Diameter 7.20"

116B-1



Compressed Height 2.10"
 Extended Height 7.50"
 Ride Height 5.00" - 6.00"
 Max. Diameter 9.20"

6868

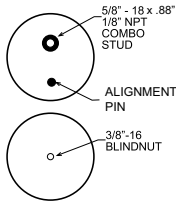

6869

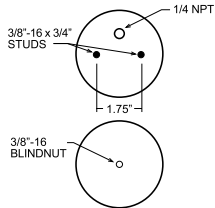

1132

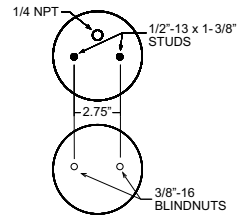

1800 lbs. per air spring*

3000 lbs. per air spring*

268C



Compressed Height 2.80"
 Extended Height 7.00"
 Ride Height 4.50" - 5.50"
 Max. Diameter 6.40"

6761

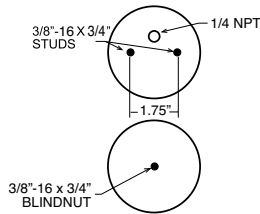

6762

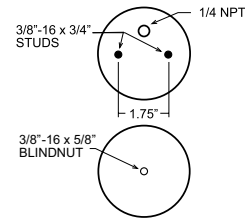

6764

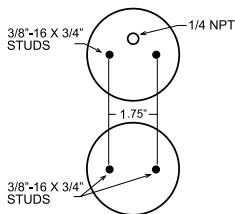

6765

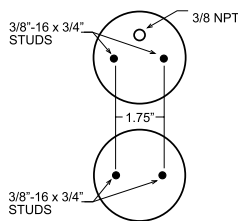

6766

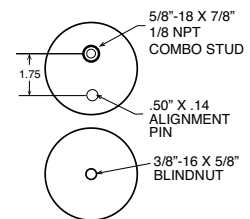

1600 lbs. per air spring*

267C 1.5



Compressed Height 2.80"
 Extended Height 8.30"
 Ride Height 5.50"- 6.50"
 Max. Diameter 6.60"

6397

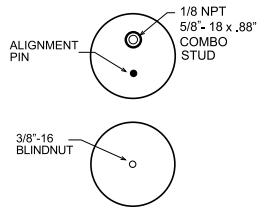

6410

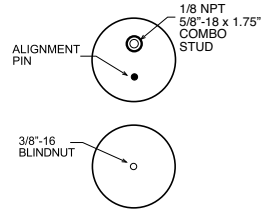

6781

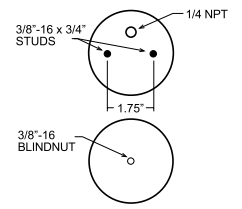

6782

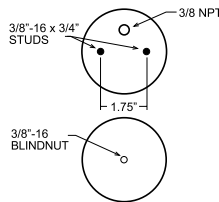

6784

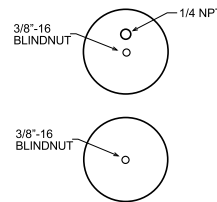

7882

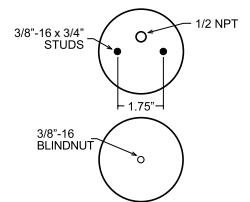

2400 lbs. per air spring*

224C



Compressed Height 3.00"
 Extended Height 8.91"
 Ride Height 5.50"-7.00"
 Max. Diameter 7.52"

0335

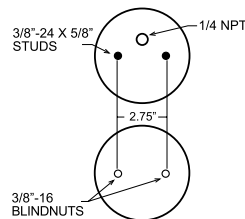

6401

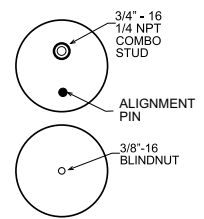

6776

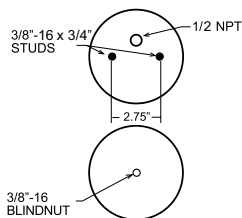

6872

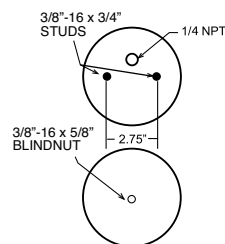

6859

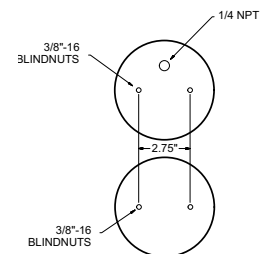

2500 lbs. per air spring*

26C



Compressed Height 3.00"
 Extended Height 9.00"
 Ride Height 7.00" - 8.00"
 Max. Diameter 8.60"

6714

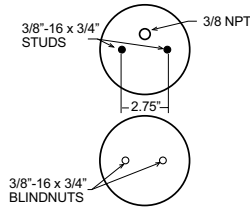

7714

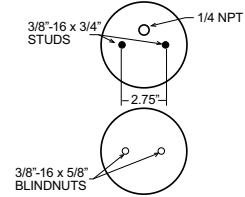

7325

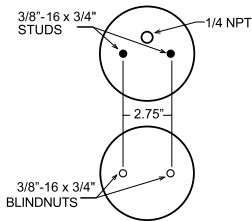

7689

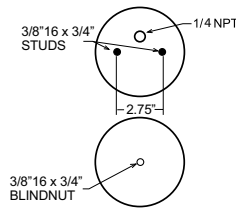

7701

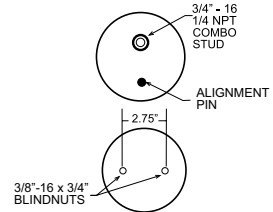

2800 lbs. per air spring*

140/95



Max. Diameter 6.44"

9041

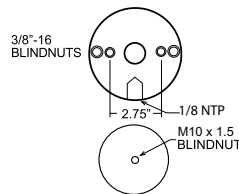

Compressed Height 8.50"
 Extended Height 13.25"
 Ride Height 10.9"

9042

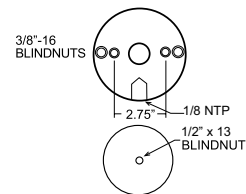

Compressed Height 6.50"
 Extended Height 11.50"
 Ride Height 9.00"

9043

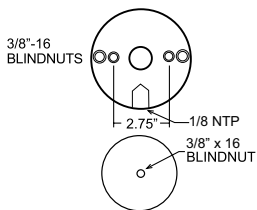

Compressed Height 6.90"
 Extended Height 12.75"
 Ride Height 9.84"

9047

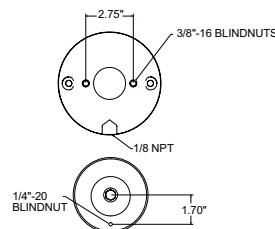

Compressed Height 8.00"
 Extended Height 17.80"
 Ride Height 11.34"

9055

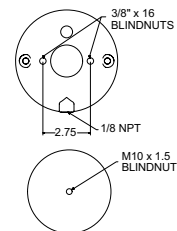

Compressed Height 6.50"
 Extended Height 13.50"
 Ride Height 8.90"

1500 lbs. per air spring*

*Load is nominal @ 100 PSI. Load will vary with height & pressure. Values shown are at ride height.

110/70



Max. Diameter 5.70"

9000

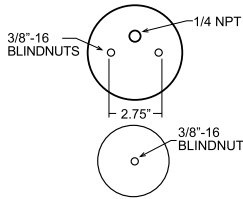

Compressed Height 6.25"
Extended Height 10.25"
Ride Height 8.25"

9001

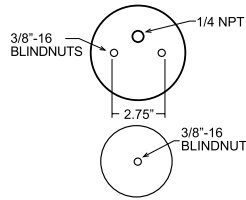

Compressed Height 4.37"
Extended Height 8.37"
Ride Height 6.38"

9002

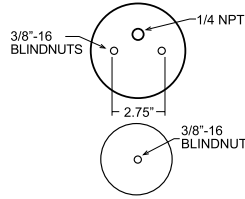

Compressed Height 5.25"
Extended Height 9.25"
Ride Height 7.25"

70mm



7076

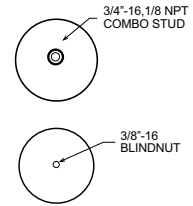

Compressed Height 3.95"
Extended Height 10.50"
Ride Height 7.00"
Max. Diameter 5.00"

1500 lbs. per air spring*

1000 lbs. per air spring*

IT14CB



5295

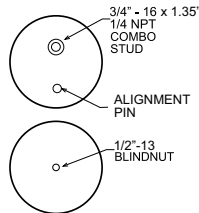

Ride Height 6.70"
Maximum Diameter 9.20"

IT14CI



2107

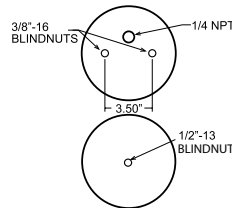

Compressed Height 4.25"
Extended Height 13.60"
Ride Height 9.80"
Max. Diameter 9.10"

IT14C3



5405

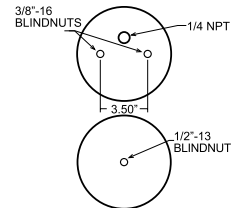

Compressed Height 5.80"
Extended Height 15.75"
Ride Height 10.50"
Max. Diameter 9.10"

5294

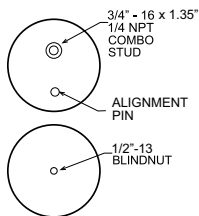

Ride Height 6.00"
Maximum Diameter 9.20"

2093

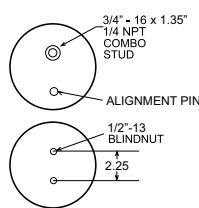

Ride Height 7.75"
Maximum Diameter 9.20"

3200 lbs. per air spring*

3200 lbs. per air spring*

Inflation Valve

(PACKAGES OF 6)

3457 - 1/4" tubing

(PACKAGES OF 25)

3032 - 1/4" tubing



Male Connector

(PACKAGES OF 6)

3454 - 1/4" tubing - 1/8 NPT

3455 - 1/4" tubing - 1/4 NPT

(PACKAGES OF 25)

3055 - 1/4" tubing - 1/8 NPT

3046 - 1/4" tubing - 1/4 NPT

3277 - 3/8" tubing - 1/8 NPT

3104 - 3/8" tubing - 1/4 NPT

3154 - 3/8" tubing - 3/8 NPT

3157 - 1/2" tubing - 1/2 NPT



Male Elbow

(PACKAGES OF 6)

3456 - 1/4" PTC

(PACKAGES OF 25)

3128 - 1/4" tubing - 1/8 NPT

3031 - 1/4" tubing - 1/4 NPT

3103 - 3/8" tubing - 1/4 NPT

3153 - 3/8" tubing - 3/8 NPT

3289 - 1/2" tubing - 1/4 NPT

3290 - 1/2" tubing - 3/9 NPT



Union Tee (Push To Connect)

(PACKAGES OF 6)

3453 - 1/4" tubing

(PACKAGES OF 25)

3025 - 1/4" tubing

3105 - 3/8" tubing



Male Branch Swivel Tee

(PACKAGES OF 25)

3047 - 1/4" tubing - 1/8 NPT

3273 - 1/4" tubing - 1/4 NPT

3279 - 3/8" tubing - 1/4 NPT



Pressure Switch

(PACKAGED INDIVIDUALLY)

9106 - 1/8 NPT Male, 90–120 PSI

9193 - 1/8 NPT Male, 100–150 PSI



Sealed Pressure Switch

(PACKAGED INDIVIDUALLY)

9401 - 1/8 NPT Male, 90–120 PSI

9402 - 1/8 NPT Male, 110–145 PSI



Compressor Check Valve

(PACKAGES OF 25)

9399 - 1/8 NPT



Compressor Tee

(PACKAGED INDIVIDUALLY)

3066 - 1/4" tubing - 1/8 NPT



Union

(PACKAGES OF 10)

3079 - 1/4" tubing

3114 - 1/4"–3/8" tubing



Straight Female

(PACKAGES OF 10)
3082 - 1/4" tubing - 1/8 NPT
3083 - 1/4" tubing - 1/4 NPT



Tubing Cutter

(PACKAGED INDIVIDUALLY)
9009 - Air Line Cutter



Coil-Rite Elbow Fitting

(PACKAGES OF 2)
3438 - Shrader to Push to Connect



Coil-Rite Straight Fitting

(PACKAGES OF 2)
3439 - Shrader to Push to Connect



Wire Harness with Relay

(PACKAGED INDIVIDUALLY)
9307 - Switch Active
9419 - Ignition Active



Inflation Valve Bracket

(PACKAGED INDIVIDUALLY)
7560



Fuse Tap Kit

(PACKAGED INDIVIDUALLY)
2526 - The Fuse Tap Kit provides an easy, low-impact method to connect the wire harness to the fuse box without splicing or soldering. Keeps the original circuit intact.



Extension Hose

9006 - This 25-ft extension hose is included in the following popular Air Command Kits:

- 2047** Air Command
- 2540** Remote Air Command
- 2541** Heavy Duty Remote Air Command
- 2266** Xtra Air Command-Single
- 2168** Xtra Air Command-Dual
- 2546** Xtra Remote Air Command
- 2547** Xtreme Remote Air Command



Helpful Tools

The scale shown below may be used to assist in identifying the correct NPT (National Standard Taper Pipe Thread) fitting. Thread sealant is applied to the tapered threads. If the fitting is removed, use Teflon tape during reinstallation to prevent air leaks.

SHOWN ACTUAL SIZE

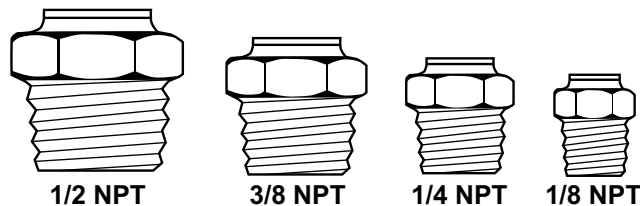

NPT Size	Nominal Outside Diameter
1/2	0.840"
3/8	0.675"
1/4	0.540"
1/8	0.405"

Dealer Fitting Pack 1

2359

Includes 4 each: 1/4" union tees, inflation valves, 1/4 NPT elbow fittings



Dealer Fitting Pack 2

2360

Includes 4 each: 1/4" union tees, inflation valves, 1/4 NPT elbow fittings and 2 each: 1/4" unions, 1/4 NPT straight fittings



Dealer Fitting Pack 3

2395

Includes 6 each: 1/4 NPT elbow fittings, inflation valves

Includes 2 each: union tees, 1/4 NPT straight fittings, union fittings.

Also includes 100' of 1/4" air line tubing



Dealer Fitting Pack 4

2567

Includes 4 each: 1/4" union tees, inflation valves, 1/8 NPT straight fittings



Ride-Rite™/Sport-Rite™ Air Line Service Kit

2012

Includes 18' of red 1/4" air line, two 1/4 NPT elbow fitting, one union tee, and two inflation valves



Coil-Rite™ Air Line Service Kit

4131 (or 2131 for 8 per box)

Includes 18' of blue 1/4" air line with attached elbow fittings, two inflation valves, tie wraps, and fasteners



Air Line Tubing

Size	Length (ft)	Color	Part No.
1/4"	18	Red	9414
1/4"	22	Red	9415
1/4"	30	Red	9416
1/4"	100	Red	9145
1/4"	1000	Red	2135
1/4"	18	Black	9151
1/4"	30	Black	9153
3/8"	30	Black	9211
3/8"	250	Black	9156
3/8"	1000	Black	9143
1/2"	50	Black	9253



Firestone offers a wide selection of air tanks ranging from 1/4 gallon to 20 gallons. These air tanks are coated internally and externally to resist corrosion. They are tested to SAE J10 compliance and capable of 150 PSI maximum pressure.

1/4 Gallon Air Tank

9166

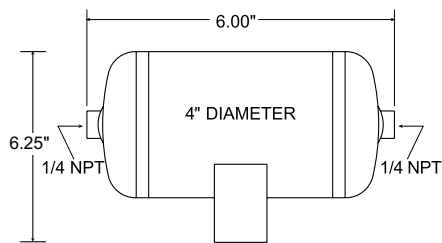

1/2 Gallon Air Tank

9124

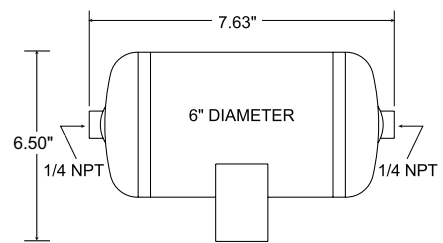

1 Gallon Air Tanks

9125

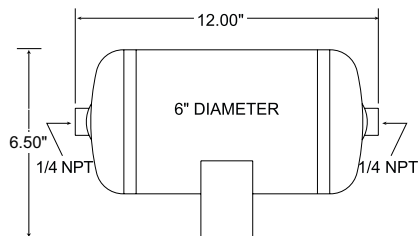

9244

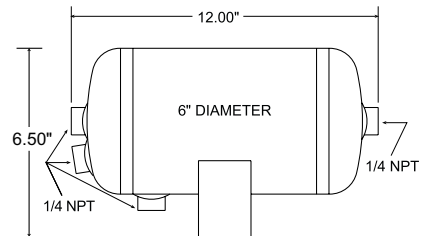

2 Gallon Air Tanks

9420

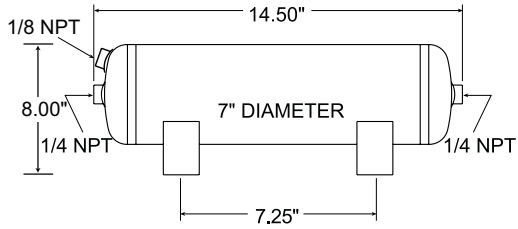

9126

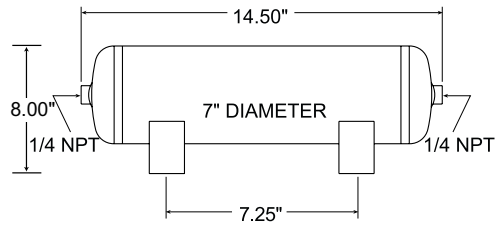

3 Gallon Air Tanks

9127

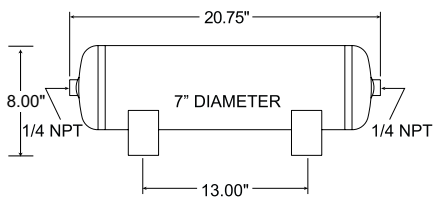

9148

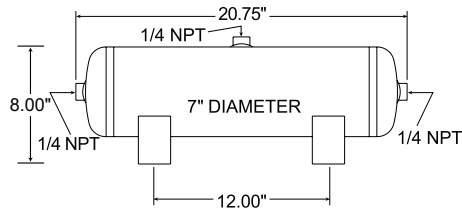

9227

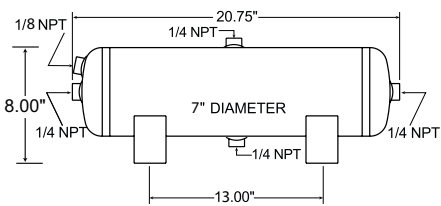

9154

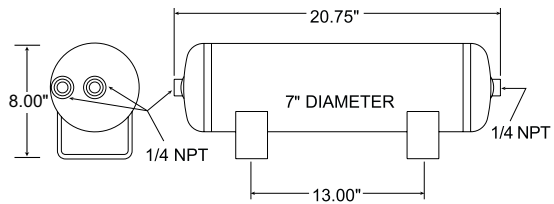

9229

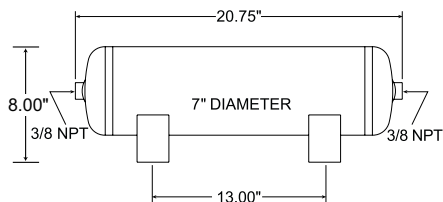

9245

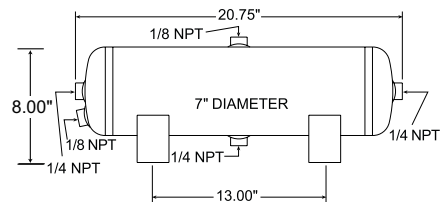

5 Gallon Air Tanks

9191

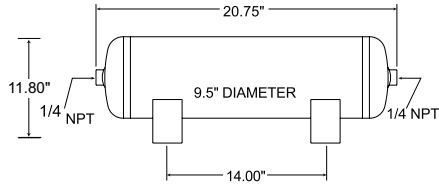

9228

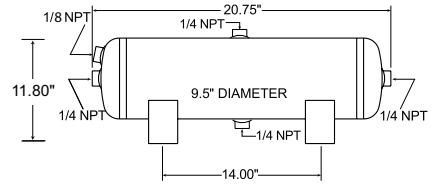

9231

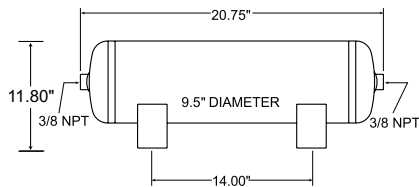

9242

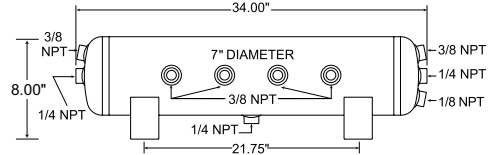

9243

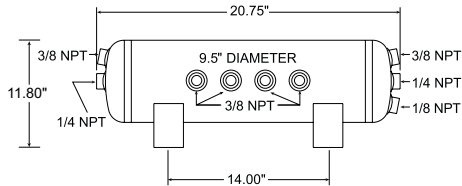

9246

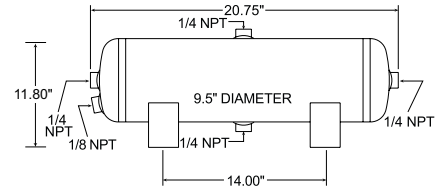

9248

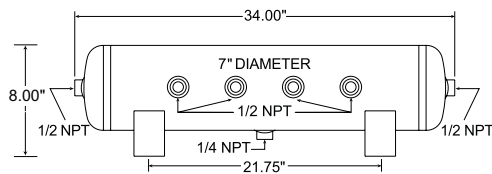

20 Gallon Air Tank

9277

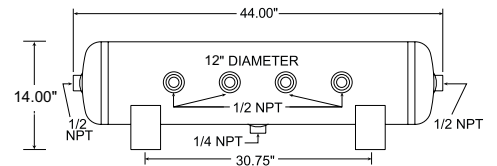

Metal Control Panels

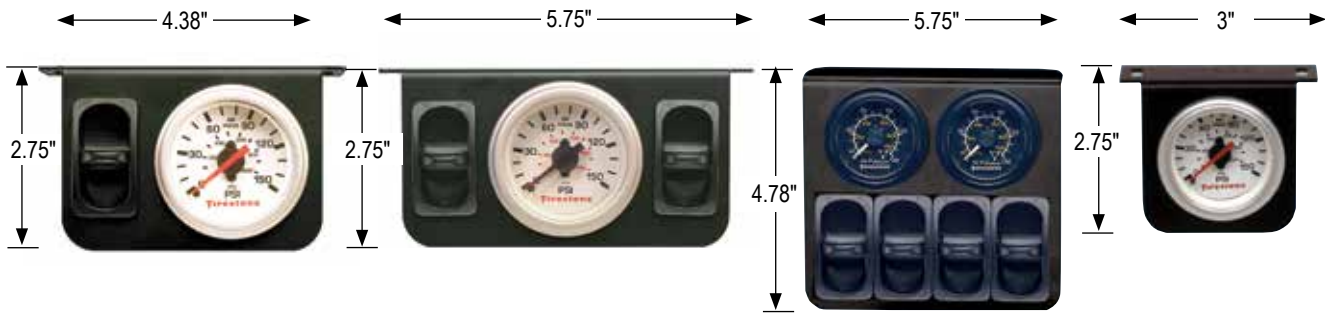

Pneumatic		Replacement Gauge
White	2225	9181
Black	2149	9084
Electric		Replacement Gauge
White	2229	9181
Black	2191	9084

Pneumatic		Replacement Gauge
White	2241	9201
Black	2145	9073
Electric		Replacement Gauge
White	2260	9201
Black	2188	9073

Pneumatic	
Black	2333

Monitoring Gauge	
White	2196

Replacement Switch	
Pneumatic	9074 - With Air Tank
Electric	9039 - No Air Tank

Plastic Control Panels

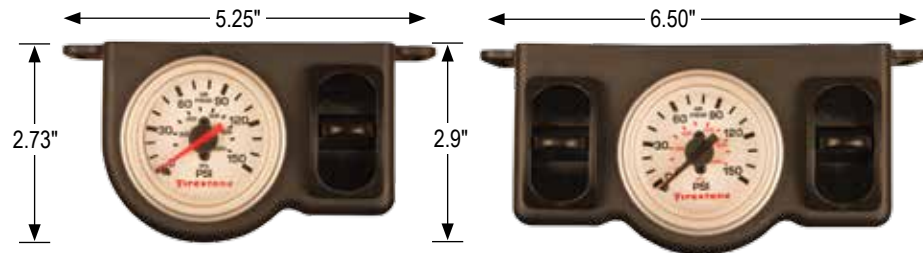

Pneumatic		Replacement Gauge
White	2570	9181
Black	2571	9084
Electric		Replacement Gauge
White	2572	9181
Black	2573	9084

Pneumatic		Replacement Gauge
White	2574	9201
Black	2575	9073
Electric		Replacement Gauge
White	2576	9201
Black	2577	9073

How do I know if I need a pneumatic or an electric control panel?

- Pneumatic control panels are used in systems that utilize tanks.
- Electric control panels do NOT require a tank.

What is the difference between single and dual control panels?

- Single control panels inflate and deflate one pair of air springs.
- Dual control panels inflate and deflate two individual air springs or two pairs.

Firestone's air compressors are included in most Air Command™ systems but may also be purchased separately. All Firestone compressors are direct drive compressors (no oil or belts), so the compressors can be mounted in any position. Compressors should be mounted in a clean air location.



9377

L	W	H
7.63	2.11	4.31



9284

L	W	H
6.30	3.27	5.20



9285

L	W	H
8.25	3.94	6.34



9287

L	W	H
11.24	3.94	6.85



2559

L	W	H
8.4	3.75	7



2569

L	W	H
8.4	2.99	6.42



9164

L	W	H
12.54	5.65	8.86

TECH TIP

Do Not Submerge.

The compressors are designed to withstand the normal driving conditions of debris and moisture. Care should be taken that the compressors are not submerged into water.

Air Compressor Description	Part No.	Max. Air Pressure	Duty Cycle	Max. AMP Draw	0 - 30 PSI*	0-60 PSI*	Wty** (yr)	Repl. Filter	CFM @ 100 PSI*
Light Duty (Not for use with air tanks)	9377	120 PSI (8.3 BAR)	9%	10 AMPS	17 sec.	42 sec.	1	9129 ⁺	.32
Standard Duty (Use with up to 1 gallon tank)	9284	130 PSI (9.0 BAR)	15%	20 AMPS	13 sec.	30 sec.	1	9350	.57
Heavy Duty (Use with up to 3 gallon tank)	9285	150 PSI (10.4 BAR)	30%	18 AMPS	10 sec.	24 sec.	2	9418	.74
High Performance (Use with up to 6 gallon tank)	2559	175 PSI (12.0 BAR)	50%	27 AMPS	9 sec.	18 sec.	2	9428	.95
Super Performance (Use with up to 6 gallon tank)	2569	300 PSI (20.7 BAR)	50%	35 AMPS	8 sec.	16 sec.	2	9428	1.09
Xtreme (Use with up to 6 gallon tank)	9287	100 PSI (6.9 BAR)	100%	23 AMPS	7 sec.	18 sec.	2	–	.94
Xtreme -alt (Use with up to 6 gallon tank)	9164	100 PSI (6.9 BAR)	100%	28 AMPS	–	–	2	–	1.10

*Indicates flow rate - how long it takes to fill 1/2 gallon air tank.

** See product-specific warranty guidelines for more information regarding warrantable manufacturing defects.

*Packs of 10 filters.



Mounting Kits

Firestone's Air Accessory Mounting Kits allow the compressor only, tank only or entire air accessory system to be pre-assembled table top, before the vehicle is on the lift. The plate with the assembled accessory system can easily be attached to the frame, without drilling using bail clamps.



2518 Kit Installed on Dodge 1500 which includes the 2496 and 2529 Air Accessory Mounting Kits.



Air Accessory Mounting Kit 2497 shown with 9287 compressor.



Air Accessory Mounting Kit 2529 shown with Kit 2541 preassembled.

For Air Tanks

2496 - Brackets clamp to vehicle with u-bolts. Will fit all Firestone tanks except 9166. Will also work with the following kit: 2546*



For Air Command Kits

2529 - Compressor, ECU and valve block mount to plate without drilling. Plate clamps to vehicle with u-bolts. Will work with the following kits:

- 2489
- 2490
- 2491
- 2540
- 2541
- 2544
- 2545
- 2546*
- 2547*
- 2554
- 2555
- 2556



For Compressors

2497 - Will work with the following kits:

- 2097
- 2158
- 2178
- 2219
- 2538
- 9284
- 9285
- 9287
- 9377



For Air Tank and Compressor

2530 - Will work with the following kits:

- 2047
- 2168
- 2198
- 2232
- 2239
- 2266
- 2543
- 2547*
- 2549



*This kit requires two mounting plates. For **2546 Xtra Remote Air Command**, use the 2529 and 2496. For **2547 Xtreme Remote Air Command**, use the 2529 and 2530.

Level Command System™

Level Command Systems are comprised of an air supply kit and a height sensor kit to automate the inflation of your air springs, keeping them at a controlled height.







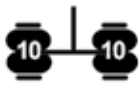

Air Supply Kits

Air Supply Kits offer an on-board air source for inflating air springs, tires, rafts and other pneumatic components. Kits include a compressor, an air tank and a 25 ft. extension hose.

Kit Part #	2047 (Xtra)	2239 (Xtra 3 Gallon)	2548 (Xtreme)
COMPRESSOR	 9285	 9285	 9287
AIR TANK	 9124	 9127	 9420
HOSE	 9006	 2311	 2311

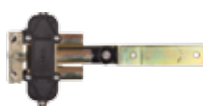
Height Sensor Kits

Height Sensor Kits automatically control the air spring height. Choose from mechanical/pneumatic or electrical for single or dual height leveling. mechanical or electric versions.

Kit Part #	Mechanical/Pneumatic		Electronic	
	2186	2017	2533	2534
	Single 	Dual 	Single 	Dual 
Xtra & Xtreme				



Air Command™ Air Control Systems

Firestone has expanded the offering of Air-Rite Air Control Systems, which provides an instant air source for air suspension products. Adjust the ride for various load and road conditions with a flip of a switch or even a click on a remote. Individual air accessory components are also available, including compressors, air tanks and mounting solutions, providing a wide variety of air control assist solutions.

- Step 1** Choose the application you need; Single or Dual Leveling »
- Step 2** Choose the style you want to control your air; Analog, Digital, or Wireless »
- Step 3** Choose the Duty Cycle needed for your kit/vehicle. Recommended duty cycle is listed in the Application Guide. »

Light Duty	<ul style="list-style-type: none"> • 1-Year Warranty • Includes 9377 Compressor • Best for passenger cars, SUVs, vans, small pickups for occasional use and light loads 	
Standard Duty	<ul style="list-style-type: none"> • 1-Year Warranty • Includes 9284 Compressor • Best for moderate usage including towing boats, trailers 20' or smaller and medium loads 	
Heavy Duty	<ul style="list-style-type: none"> • 2-Year Warranty • Includes 9285 Compressor • Best for 8-lug trucks, trailers larger than 20', slide-in campers and heavy loads 	
Xtra	<ul style="list-style-type: none"> • 2-Year Warranty • Includes 9285 Compressor • Includes Half-Gallon Air Tank • Includes 9006 Air Hose • Best usage same as Heavy Duty plus motorcycle tire, golf cart tire or trailer tire inflation 	  
Xtreme	<ul style="list-style-type: none"> • 2-Year Warranty • Includes 9287 Compressor • Includes 2-Gallon Air Tank • Includes 2311 Air Hose • Best usage same as Heavy Duty plus off-road tire or truck tire inflation. 	  

Single Leveling System

Equal pressure to the springs on both sides. This applies to most towables using a hitch.



Analog



Digital

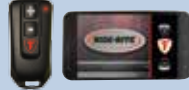

Wireless

2538

Mounting Plate: 2497

2490

Mounting Plate: 2529

2555
(Key Fob)
2556
(Android App)

Mounting Plate: 2529

2158

Mounting Plate: 2497

2544

Mounting Plate: 2529

N/A

2097

Mounting Plate: 2497

N/A

N/A

2266

Mounting Plate: 2530

N/A

N/A

2543

Mounting Plate: 2530

N/A

N/A

Dual Leveling System

Allows for side-to-side or front-to-back leveling. This applies to work trucks, in-bed campers, and off-center loads.



Analog



Digital



Wireless

N/A

2491

Mounting Plate: 2529

2554
(DIFFERENT REMOTE)

Mounting Plate: 2529

2178

Mounting Plate: 2497

2545

Mounting Plate: 2529

2540

Mounting Plate: 2529

2219

Mounting Plate: 2497

N/A

2541

Mounting Plate: 2529

2168

Mounting Plate: 2530

N/A

2546

Mounting Plates: 2529/2496

2549

Mounting Plate: 2530

N/A

2547

Mounting Plates: 2529/2530



With one of the strongest sales networks in the industry, Firestone stands behind every one of our dealers, helping you sell with solid marketing practices. Firestone has made a commitment to its dealers to provide national assistance through the use of an aggressive marketing campaign and a comprehensive web site.

Counter Display

9977

Counter displays are available to create customer interest. There is a Firestone air helper spring included with the display so your customers can see exactly what the product looks like.

Includes 1 pack 8191.



To Order Literature:
1. Order through your distributor
2. Call 1-800-888-0650, ext. 58643.

Counter Mat

9988

Promote sales with our full color 16"x20" counter mat. A great marketing piece to attract attention.



Counter Board

9978

The Ride-Rite Counter Board can hold a 25-pack of Consumer Brochures.

8191 Not included



Ride-Rite Gloves

(Packaged Individually)

Small/Med. 9345

Large 9346



Consumer Brochure

8191

Learn in detail what Firestone air helper springs can do for your ride in our consumer brochure.

25 per pack

(used in 9985, 9996 and 9999)



Ride-Rite Decal

9372

Use the popular 3"x6" Ride-Rite decal on windows, tool boxes or as counter giveaways.

100 per pack



Product Packaging

9985

Show your customers Firestone's full color retail packaging and spark interest with our product lines. Includes two Ride-Rite display boxes, one Coil-Rite and one Air Accessory boxes. Also included are 9987, 9189, 8191 and 8207.



Ride-Rite Part Display

9999

18" w x 18.5" h (19.5 lbs) display with plastic pocket and 25 brochures



Ride-Rite Banner

9981

Let your customers know you stock Ride-Rite Air Helper Springs with this 2' x 5' indoor/outdoor banner.



Ride-Rite Dealer Pack

9976

Includes the above banner, window cling and decal.

Ride-Rite 2-Sided Window Cling

9979

8" x 11"



Ride-Rite Large Decal

9982

This durable decal can also be used on walls and counter tops.



LAMA

9975

20" wide x 60" tall pop-up display





2015 Ford F150 Ride-Rite Kit

2582

The 2015 Ford F150 kit will be available soon. This no drill kit uses existing holes in the frame for easy installation. Our newest kit is designed to position the air spring between the frame and the axle for maximum stability, improves overall handling and supports up to 5,000 lbs (not to exceed vehicle's GVWR).



2014-15 Ram 2500 Ride-Rite Kit

2580

The highly anticipated 2014 RAM 2500 Ride-Rite kit is available to order! This no drill kit uses existing holes in the frame for easy installation. Our newest kit was designed to position the air spring between coil spring and tire for maximum stability. Improves overall handling and supports up to 5,000 lbs (not to exceed vehicle's GVWR).



Ford F150 Raptor Kit

2565

New to the Ride-Rite product line is the 2009-2014 Ford Raptor Sport-Rite kit. This no-drill kit uses existing holes in the frame for easy installation. Includes an innovative tapered sleeve air spring for maximum travel while maintaining a smooth ride. Improves overall vehicle handling and supports up to 3,000 lbs (not to exceed vehicles GVWR).

Compact Remote Air Command™ Kit and Air Command™ Kit for Android



Our two newest wireless options allow you to remotely control the amount of air in your Ride-Rite Air Springs. Both kits include an Electronic Control Unit (ECU) and a light duty compressor.

2555 – Includes key fob remote controller

2556 – Includes instructions for downloading the Firestone Ride-Rite Air Command™ App from Google Play (Android phone not included)



Air Spring Alignment – Air spring alignment is important to the operation of your air helper spring kit. Upon installation, visually align the air spring. Most kits allow for adjustment of the upper and lower brackets to assist in making the air springs vertical. In most instances, position the upper and lower brackets so that they are parallel. Remember to maintain proper design height. Refer to the installation manual for kit-specific procedures.

Push-to-Connect Fittings – Firestone's push-to-connect air fittings are extremely easy to use. Once the length of the air line has been selected to span the distance from the air springs to the inflation valves, simply use a sharp knife or tubing cutter (9009) to cut the air line as square as possible (Do NOT use side cutters or other devices that may smash the end of the air line). Then push the air line into the fitting as far as possible.

Air Spring Pressure – Never run the air spring under the minimum recommended pressure. Never exceed the maximum recommended pressure.

Heat Sources – Make sure there is at least 6" of clearance between the air spring and the nearest heat source. Kits for vehicles with less than this clearance have a heat shield included. Our kits are designed to work around factory exhaust systems. Aftermarket systems with larger tubes may cause interference or put heat too close to the air spring, which will damage the rubber.

Air Spring Clearance – After installing your air helper spring kit, make sure you have at least 1/2" of clearance around the entire air spring when inflated. A good rule of thumb is to use the thickness of your hand and feel around the entire air spring. If your hand comes in contact with anything on the vehicle, you may have an interference issue. If the object can be moved, relocate it. If the object cannot be moved, contact Firestone for further assistance. No part of the air spring kit (bellows, brackets, hardware) should rub on any lines (fuel, brake, electric) or contact anything but the mounting surfaces designed to support the brackets.

Air Accessory Systems – Firestone offers a wide range of air accessory systems for all your air helper spring requirements. Some quick tips that apply to all Firestone air accessories:

- 1.) All compressors are direct drive units (NO oil or belts). This means the compressor can be mounted in any position without detriment to the compressor.
- 2.) In systems using tanks, when connecting the compressor to a positive wire on the vehicle, make sure the wire is ignition activated. This will eliminate the possibility of the compressor running while the vehicle is turned off, draining your battery.
- 3.) The compressor can be mounted under the hood or on the frame rail behind a cross member. In order to allow enough air flow to the compressor, place the unit in a well protected area free from debris and large amounts of water.



Coverage

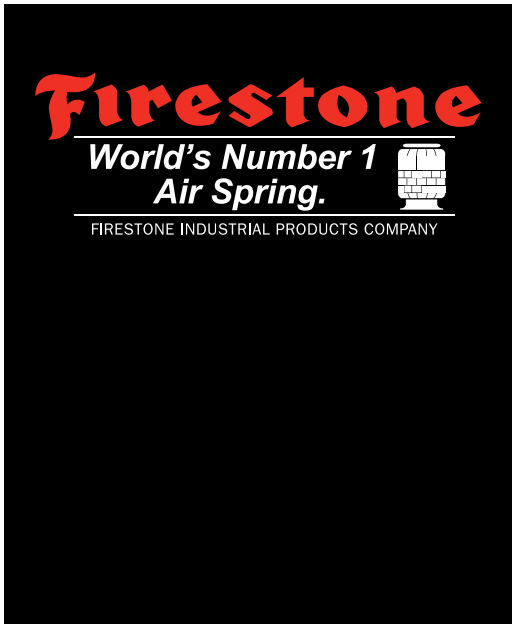

What's covered –

The Ride-Rite kits, components and accessories are warranted against defects in workmanship and materials*.

What's not covered –

This warranty does not cover service or labor charges, freight or customs charges, neglect, abuse, misuse, misapplications, improper installation, failure due to external conditions or interference, overloading or alterations to the product.*

What's the period of coverage* –

Work-Rite Kits

- Bumpers, Hardware & Brackets = 2 years

Air-Rite Accessories

- Brackets, Hardware, Fittings & Air Line = 2 years

Ride-Rite, Sport-Rite, Coil-Rite, Level-Rite Kits

- Air Springs = Limited Lifetime
- Hardware & Brackets = 2 years

Ride-Rite Warranty Evaluation Guide

Firestone air springs are designed to provide years and thousands of miles of trouble free service. The durability of Firestone air springs is such that they will often outlast other maintenance items on your suspension, such as bushings, shocks and other components. Ride-Rite air springs are warranted to be free of material defects and/or workmanship for as long as the original purchaser owns the vehicle on which it was originally installed. The hardware and brackets which accompany the air spring are warranted for a period of twenty-four (24) months or 24,000 miles whichever occurs first. This warranty begins on the original retail delivery date. Replacement parts determined by Firestone to be warrantable may be provided by Firestone. All labor and incidental costs associated with replacing the defective air spring are the responsibility of the consumer.

Firestone Industrial Products Company offers a complete line of air springs, with products available for a variety of applications. Since each individual air spring is closely examined and pressure tested at the factory, the vast majority of premature failures and consequent warranty returns are found not to be defective and fail because of abuse caused by other problems associated with the suspension.

The information on the following pages was developed to illustrate the types of failures that may occur and to assist you in determining the cause and corrective action required.

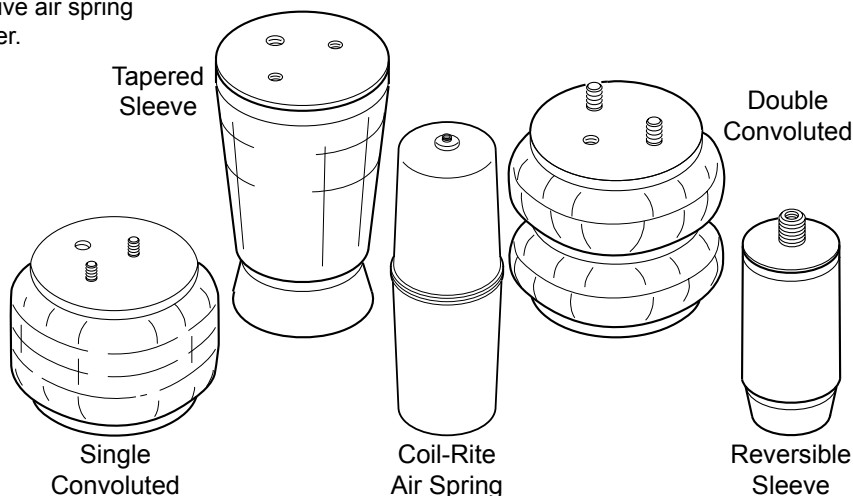



Compressor Cylinder Body

Appearance/Condition

- Compressor will not start
- Compressor will not pump air

Possible Causes

- Compressor was submerged
- Compressor inlet has pulled in moisture from environment

Possible Solutions

- Replace compressor
- Snorkel air filter to a dry, dust free location (max. 6ft.)

NOT COVERED UNDER WARRANTY



Crank and Rod

Appearance/Condition

- Compressor will not start
- Compressor will not pump air

Possible Causes

- Compressor was submerged
- Compressor inlet pulled in moisture from environment

Possible Solutions

- Replace compressor
- Snorkel air filter to a dry, dust free location (max. 6ft.)

NOT COVERED UNDER WARRANTY



Inlet Plate

Appearance/Condition

- Rust around threads of inlet port
- Compressor doesn't pump air
- Compressor runs at high current (blows fuses)

Possible Causes

- Compressor was submerged
- Air filter assembly was not installed properly

Possible Solutions

- Snorkel air filter to a dry, dust free location (max 6ft)
- Replace compressor

NOT COVERED UNDER WARRANTY



Brushes / End Plate / Motor Housing

Appearance/Condition

- Compressor will not start

Possible Causes

- Compressor was submerged
- Compressor has stuck brushes

Possible Solutions

- Lightly tap on compressor motor housing farthest from compressor head
- Replace compressor

COVERED UNDER WARRANTY

Firestone air springs are designed and built to the highest of standards and will provide years and thousands of miles of trouble-free service. Most failures are caused by improper application, installation, misuse and abuse. The following examples are common failures that are **NOT covered under warranty**.



NOT COVERED UNDER WARRANTY

Rubber Bellows Close-up

Puncture

Appearance or Condition

- Irregular shaped cut in the bellows

Possible Causes

- Debris punctured the bellows
- Mounted too close to a sharp object

Punctures are not a warrantable failure.



NOT COVERED UNDER WARRANTY

Convolute Shown

Bent Alignment Pin

Appearance or Condition

- One side of alignment pin is pushed down toward the bead plate
- Marring or semicircular gouge in the top of the alignment pin

Possible Cause

- Alignment pin was not installed into the alignment pin hole in the bracket



NOT COVERED UNDER WARRANTY

Convolute Shown

Abrasion

Appearance or Condition

- Hole rubbed into side of bellows or in area that rolls over piston (sleeve style)

Possible Causes

- Contacting a vehicle or other suspension component
- No air pressure
- Road debris
- Oversized tire contact
- Snow chain contact
- Inadequate tire to frame clearance



NOT COVERED UNDER WARRANTY

Convolute Shown

Circumferential Cuts

Appearance or Condition

- Bellows cut or separated around the perimeter of bead plate or piston

Possible Causes

- High pressure, over extended for long periods of time
- Bottoming out



NOT COVERED UNDER WARRANTY

Bent Brackets

Appearance or Condition

- Distorted shape
- Possible cracking or "tearing"

Possible Causes

- Not enough pressure in the system for the load
- Overloading the vehicle/air springs

Bent and damaged brackets are not covered under warranty.

Broken Piston

Appearance or Condition

- Cracked or broken piston

Possible Causes

- Road debris
- Not enough pressure in the system for the load
- Overloading the vehicle/air springs
- Installed height of air spring too short



NOT COVERED UNDER WARRANTY

Bottom of tapered sleeve shown (Sport-Rite application).



Tapered sleeve shown.

Bottoming Out

Appearance or Condition

- Bent brackets or beadplates
- Broken girdle hoop (convoluted parts), caps or pistons (sleeve parts)
- Cuts near the bead plates, caps, or pistons
- Leaking around blind nuts

Possible Causes

- Installation height is too low
- Not maintaining the minimum air pressure
- Not enough air pressure for the load
- Overloading the vehicle/air springs
- Installed height of air spring too short

Broken pistons, bottomed out and cuts are not covered under warranty.



NOT COVERED UNDER WARRANTY



NOT COVERED UNDER WARRANTY

Coil-Rite

High Temperature / Over Inflation

Appearance or Condition

- Tear in the side of the part, material seems thin or "stretched".

Possible Causes

- Exposed to high temperature for long periods of time (too close to exhaust)
- Over inflation (see manual for max operating pressure)



NOT COVERED UNDER WARRANTY

Convoluted shown.

Cracked / Hard Bellows

Appearance or Condition

- Cracking in bellows around bead plates and caps or where the sleeve rolls over the piston
- Hard to the touch, no longer flexible

Possible Causes

- Exposed to high temperature for long periods of time
- Old air spring — Rubber ages and will wear out eventually. The air spring is not warrantable and needs to be replaced.



Preventative Maintenance

Prior to installation, check to ensure that all minimum clearance requirements are met.

During installation, make sure that the air spring is installed at the correct mounting height or ride height.

After installation, check the tightness of all mounting hardware. Torque specifications can be found in the Operating Guide included with each kit.

After installation, inflate the air springs to 10 psi and maximum pressure (see installation manual) to ensure that there is at least a 1/2 inch of clearance around the air spring (non-Coil-Rite applications). A good way to check the clearance is to move your hand around the air spring. If it touches anything, the air spring will most likely touch it as well. If nothing touches your hand, the air spring has enough clearance.

After installation, inflate the system to 10 psi and using a soapy water mixture, check for air leaks. Recheck for leaks at maximum pressure (see installation manual). If a leak is detected, correct the problem before using the vehicle.

Once you have ensured that there are no leaks in the system, **check pressure monthly** to maintain the minimum pressure. **DO NOT** drive a vehicle without pressure in the air springs.

Measure the distance between the air springs and the closest heat source. If the measurement is 6" or less, a heat shield will be required.

Prior to loading the vehicle, measure the distance between the fender opening and the ground. After the vehicle is loaded, inflate the air springs until the vehicle is back to the unloaded height using the measurement taken while the vehicle was unloaded. **DO NOT** exceed the maximum operating pressure outlined in the installation manual.

Periodically check for rocks, gravel, sand or other abrasive debris between the convolutions, around bead plates and around pistons. Remove the debris to help prevent abrasive punctures.

Cleaning

Although it is not necessary to clean the air springs, it is acceptable to do so if desired. The following are approved and non-approved means of cleaning an air spring.

Approved – Soap and water, methyl alcohol, ethyl alcohol, isopropyl alcohol or any product approved for cleaning tires.

Non-Approved – Organic solvents, open flames, abrasives and direct pressurized steam.



Why Ride-Rite™?

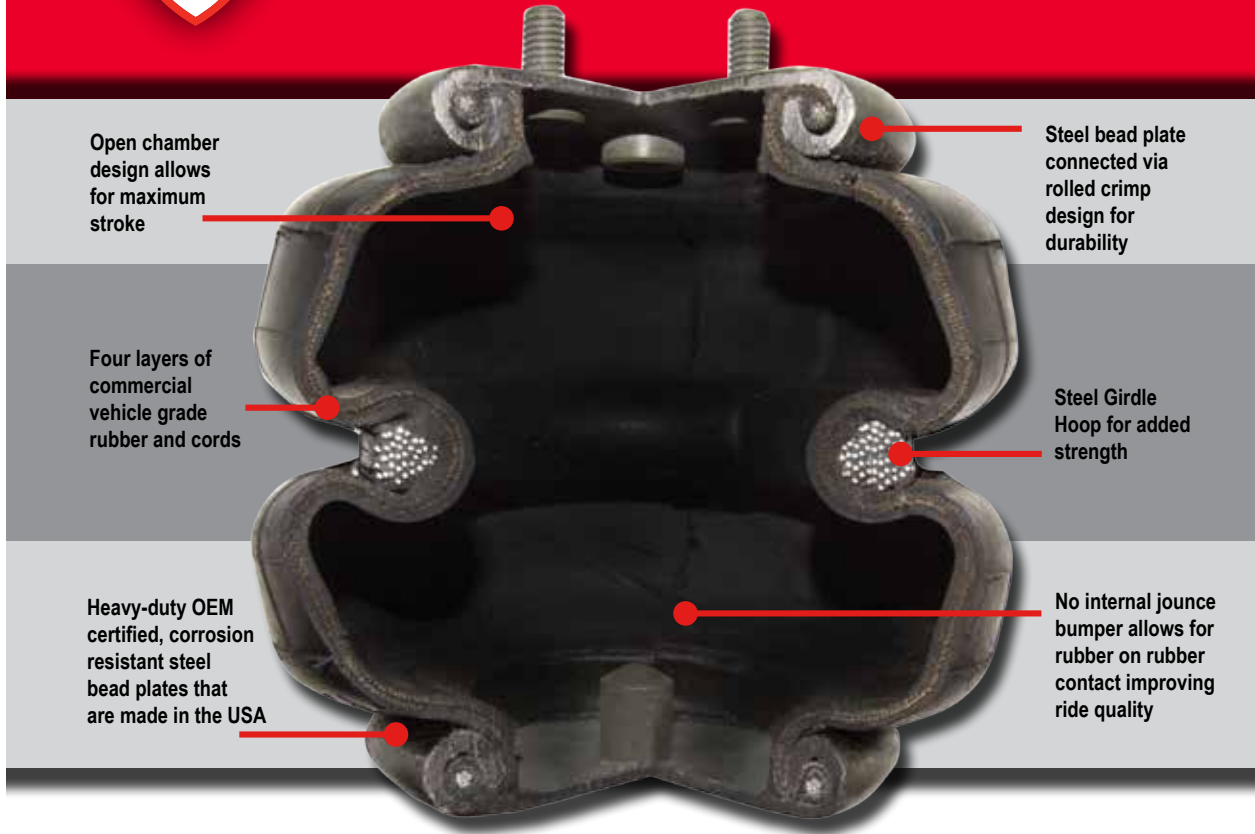

Quality. Reliability. Durability.

Firestone invented the first Airide™ Air Spring in 1938 and after 76 years, we remain the #1 Air Spring provider for a reason. Our Ride-Rite Air Springs are built on the same heavy duty technology used for buses, semis and railcars. No one puts their products through the rigorous testing and quality standards that we do.

When it comes time to choose, choose the best.



Discover other performance suspension parts on our website.